

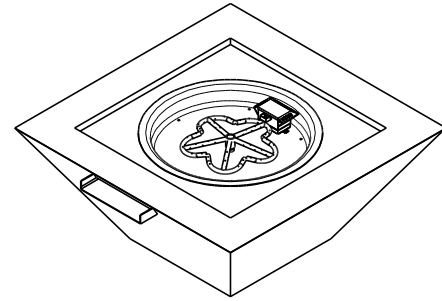

Hearth Products Controls Co
CSA CERTIFIED FIRE PIT INSERT
OUTDOOR USE ONLY

HEARTH PRODUCTS CONTROLS
 3050 PLAINFIELD RD.
 KETTERING, OH 45432
 TOLL FREE: 1-877-433-7001
 PHONE: (937) 433-7000
 FAX: (937) 433-0704
 www.hpcfire.com

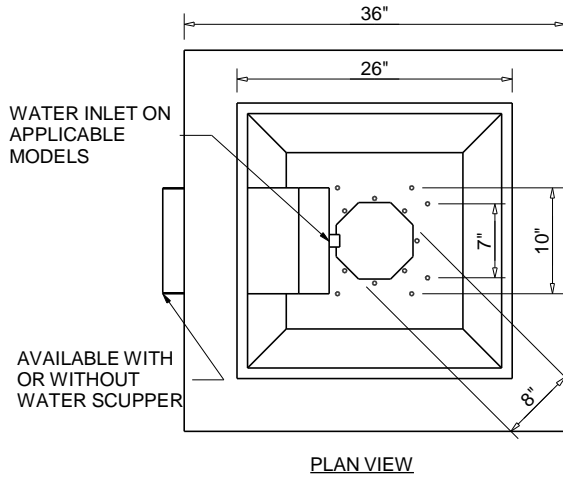

ISOMETRIC VIEW

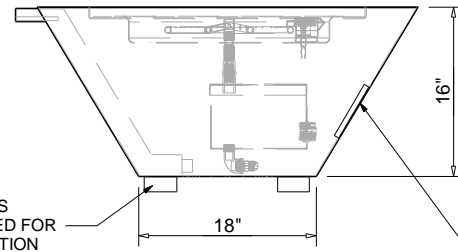

ELECTRONIC IGNITION OPTION

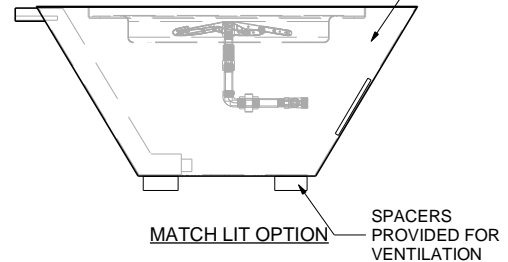

MATCH LIT OPTION

PART NUMBER	WATER SCUPPER	IGNITION	STND BTU	VOLTAGE
SIER36-HWI	NO	ELECTRONIC	65K	120VAC/24VAC
SIER36W-HWI	YES	ELECTRONIC	65K	120VAC/24VAC
SIER36-MLFPK	NO	MATCH LIT	50K	-
SIER36W-MLFPK	YES	MATCH LIT	50K	-

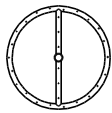

ROUND BURNER

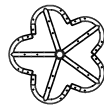

PENTA BURNER

Notes:

1. FOR USE WITH FIXED PIPING SYSTEMS ONLY.
2. NOT FOR USE WITH SMALL TANKS.
3. ALL ENCLOSURES REQUIRE 2 each 18 SQ/IN VENTS ON OPPOSING SIDES AND ADEQUATE DRAINAGE.
4. RESIDENTIAL GAS PRESSURE ONLY. (NG- 7.0" WC, LP- 11.0" WC)
5. MODIFCATION OF PRODUCT WILL VOID ANY CERTIFICATION AND WARRANTY.
6. FOLLOW ALL MANUFACTURER INSTALLATION INSTRUCTIONS AND LOCAL CODES.
7. ALL DIMENSIONS ARE CONSIDERED TRUE AND REFLECT MANUFACTURER'S SPECIFICATIONS AS OF THE REVISION DATE.
8. DO NOT SCALE DRAWING.
9. THESE DRAWINGS ARE FOR SIZING AND PLANNING PURPOSES. ALL INFORMATION CONTAINED HEREIN WAS CURRENT AT THE TIME OF DEVELOPMENT. THE MANUFACTURE IS RESPONSIBLE FOR THE ACCURACY OF THE DRAWING.
10. CONTRACTOR'S NOTE: FOR PRODUCT AND COMANY INFORMATION VISIT www.CADdetails.com/info REFERENCE NUMBER 771-021.

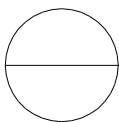

SIERRA WITH HWI FIRE PIT- FLAME SENSING WITH ELECTRONIC HOT WIRE IGNITION
 SEIRRA WITH MATCH LIT FIRE PIT INSERT