



P/N 126829-01 REV. C 01/2019



Report No. F09-100

Installation and Operation Instructions

Unvented (Vent-Free) Gas Log Heater

Models

BGE18NR	BGE18PR	BGE2436NR	BGE2436PR
---------	---------	-----------	-----------

For use with log sets

LBG18BM	LBG18SM	LBG36SM
LBG24BM	LBG24SM	
LBG30BM	LBG30SM	



We recommend that our gas hearth products be installed and serviced by professionals who are certified in the U.S. by the National Fireplace Institute® (NFI) as NFI Gas Specialists.

CERTIFIED
www.nficertified.org

INSTALLER: Leave this manual with the appliance.
CONSUMER: Retain this manual for future reference.

This appliance may be installed in an aftermarket permanently located, manufactured (mobile) home, where not prohibited by local codes. This appliance is only for use with the type of gas indicated on the rating plate. This appliance is not convertible for use with other gases.

WARNING: This appliance is for installation only in a solid-fuel burning masonry or UL127 factory-built fireplace or in a listed ventless firebox enclosure. It is design-certified for these installations in accordance with ANSI Z21.11.2. Exception: DO NOT install this appliance in a factory-built fireplace that includes instructions stating it has not been tested or should not be used with unvented gas logs.

This is an unvented gas-fired heater. It uses air (oxygen) from the room in which it is installed. Provisions for adequate combustion and ventilation air must be provided. Refer to Air for Combustion and Ventilation section on *Page 6* of this manual.



WARNING:

FIRE OR EXPLOSION HAZARD

Failure to follow safety warnings exactly could result in serious injury, death, or property damage.

- Do not store or use gasoline or other flammable vapors and liquids in the vicinity of this or any other appliance.
- **WHAT TO DO IF YOU SMELL GAS**
 - Do not try to light any appliance.
 - Do not touch any electrical switch; do not use any phone in your building.
 - Leave the building immediately.
 - Immediately call your gas supplier from a neighbor's phone. Follow the gas supplier's instructions.
 - If you cannot reach your gas supplier, call the fire department.
- Installation and service must be performed by a qualified installer, service agency or the gas supplier.

TABLE OF CONTENTS

Safety	2	Troubleshooting	29
Product Identification	5	Wiring Diagram	33
Local Codes	5	Replacement Parts	33
Unpacking	5	Service Hints	33
Product Features	6	Technical Service	33
Air For Combustion and Ventilation	6	Accessories	34
Installation	9	Specifications	36
Operation	24	Burners and Log Sets	36
Inspecting Burners	26	Parts	37
Cleaning and Maintenance	27	Warranty	43

SAFETY

WARNING: FIRE, EXPLOSION, AND ASPHYXIATION HAZARD

Improper adjustment, alteration, service, maintenance, or installation of this heater or its controls can cause death or serious injury.

Read and follow instructions and precautions in User's Information Manual provided with this heater.

 **WARNING:** This appliance is for installation only in a solid-fuel burning masonry or UL127 factory-built fireplace or in a listed ventless fire-box enclosure. It is design-certified for these installations in accordance with ANSI Z21.11.2. Exception: DO NOT install this appliance in a factory-built fireplace that includes instructions stating it has not been tested or should not be used with unvented gas logs.

 **WARNING:** Vent-free products are prohibited for bedroom and bathroom installation in the Commonwealth of Massachusetts.

 **WARNING:** This product can expose you to chemicals including Carbon Black, which is known to the State of California to cause cancer, and Carbon Monoxide, which is known to the State of California to cause birth defects or other reproductive harm. For more information go to www.P65Warnings.ca.gov

 **WARNING:** This is an unvented gas-fired heater. It uses air (oxygen) from the room in which it is installed. Provisions for adequate combustion and ventilation air must be provided. Refer to *Air for Combustion and Ventilation* section on Page 6 of this manual.

This appliance may be installed in an aftermarket,* permanently located, manufactured (mobile) home, where not prohibited by local codes. This appliance is only for use with the type of gas indicated on the rating plate. This appliance is not convertible for use with other gases.

* Aftermarket: Completion of sale, not for purpose of resale, from the manufacturer

 **DANGER:** Carbon monoxide poisoning may lead to death!

SAFETY

Continued

IMPORTANT: Read this owner's manual carefully and completely before trying to assemble, operate or service this fireplace. Improper use of this fireplace can cause serious injury or death from burns, fire, explosion, electrical shock and carbon monoxide poisoning.

Carbon Monoxide Poisoning: Early signs of carbon monoxide poisoning resemble the flu, with headaches, dizziness or nausea. If you have these signs, the fireplace may not be working properly. **Get fresh air at once!** Have fireplace serviced. Some people are more affected by carbon monoxide than others. These include pregnant women, people with heart or lung disease or anemia, those under the influence of alcohol and those at high altitudes. Natural and Propane/LP gases are odorless. An odor-making agent is added to these gases. The odor helps you detect a gas leak. However, the odor added to the gas can fade. Gas may be present even though no odor exists. Make certain you read and understand all warnings. Keep this manual for reference. It is your guide to safe and proper operation of this fireplace.

⚠ WARNING: Any change to this heater or its controls can be dangerous.

⚠ WARNING: Do not use a blower insert, heat exchanger insert or other accessory not approved for use with this heater.

⚠ WARNING: Do not allow fans to blow directly into the fireplace. Avoid any drafts that alter burner flame patterns. Ceiling fans can create drafts that alter burner flame patterns. Altered burner patterns can cause sooting.

⚠ WARNING: Do not place log scraps or volcanic stone on burner.

Due to high temperatures, the appliance should be located out of traffic and away from furniture and draperies.

Do not place clothing or other flammable material on or near the appliance. Never place any objects on the heater.

Heater base assembly becomes very hot when running heater. Children and adults should be alerted to the hazard of high surface temperature and should stay away to avoid burns or clothing ignition. Heater will remain hot for a time after shut-down. Allow surface to cool before touching.

Young children should be carefully supervised when they are in the same room with the appliance. When using the hand-held remote accessory, keep selector switch in the OFF position to prevent children from turning on burners with remote.

You must operate this heater with the fireplace screen and hood in place. Make sure fireplace screen and hood are in place before running heater. The fireplace screen shall have openings for introduction of combustion air.

Keep the appliance area clear and free from combustible materials, gasoline and other flammable vapors and liquids.

Solid-fuels shall not be burned in a fireplace in which an unvented room heater is installed.

SAFETY

Continued

Installation and repair should be done by a qualified service person. The appliance should be inspected before use and at least annually by a professional service person. More frequent cleaning may be required due to excessive lint from carpeting, bedding material, etc. It is imperative that control compartments, burners, and circulating air passageways of the appliance be kept clean.

1. WARNING: This appliance is only for use with the type of gas indicated on the rating plate. This appliance is not convertible for use with other gases.

- Do not place propane/LP supply tank(s) inside any structure. Locate propane/LP supply tank(s) outdoors (propane/LP units only).
- If you smell gas
 - shut off gas supply
 - do not try to light any appliance
 - do not touch any electrical switch; do not use any phone in your building
 - immediately call your gas supplier from a neighbor's phone. Follow the gas supplier's instructions
 - if you cannot reach your gas supplier, call the fire department
- This heater shall not be installed in a bedroom or bathroom, unless installed as a vented appliance. See *Installing Damper Clamp Accessory for Vented Operation, Page 12*. This gas log set may not be installed as a vented appliance in a bedroom or bathroom in the Commonwealth of Massachusetts.
- Before installing in a solid fuel burning fireplace, the chimney flue and firebox must be cleaned of soot, creosote, ashes and loose paint by a qualified chimney cleaner. Creosote will ignite if highly heated. A dirty chimney flue may create and distribute soot within the house. Inspect chimney flue for damage. If damaged, repair flue and firebox before operating heater.
- Do not burn solid-fuel in a masonry or UL127 factory-built fireplace in which a vent-free room heater is installed.
- If fireplace has glass doors, never operate this heater with glass doors closed. Any glass doors shall be fully opened when the appliance is in operation. If you operate heater with doors closed, heat buildup inside fireplace will cause glass to burst. Make sure there are no obstructions across openings of fireplace.
- To prevent the creation of soot, follow the instructions in *Cleaning and Maintenance, Page 27*.
- Before using furniture polish, wax, carpet cleaner or similar products, turn heater off. If heated, the vapors from these products may create a white powder residue within burner box or on adjacent walls and furniture.
- This heater needs fresh, outside air ventilation to run properly. This heater has an Oxygen Depletion Sensing (ODS) safety shutoff system. The ODS shuts down the heater if enough fresh air is not available. See *Air for Combustion and Ventilation, Page 6*. If heater keeps shutting off, see *Troubleshooting, Page 29*.
- Do not run heater
 - where flammable liquids or vapors are used or stored
 - under dusty conditions
- Do not use this heater to cook food or burn paper or other objects.
- Do not use heater if any part has been exposed to or under water. Immediately call a qualified service technician to inspect the room heater and to replace any part of the control system and any gas control which has been under water.
- Do not operate heater if any log is broken. Do not operate heater if a log is chipped (dime-sized or larger).
- Turn heater off and let cool before servicing, installing or repairing. Make sure the selector switch is in the OFF position. Only a qualified service person should install, service or repair heater.
- Make sure the selector switch is in the OFF position when you are away from home for long periods of time.
- Remote-ready heaters must not be connected to any external electrical source.
- Operating heater above elevations of 4,500 feet may cause pilot outage.
- To prevent performance problems, do not use propane/LP fuel tank of less than 100 lb. capacity (propane/LP units only).
- Provide adequate clearances around air openings.

PRODUCT IDENTIFICATION

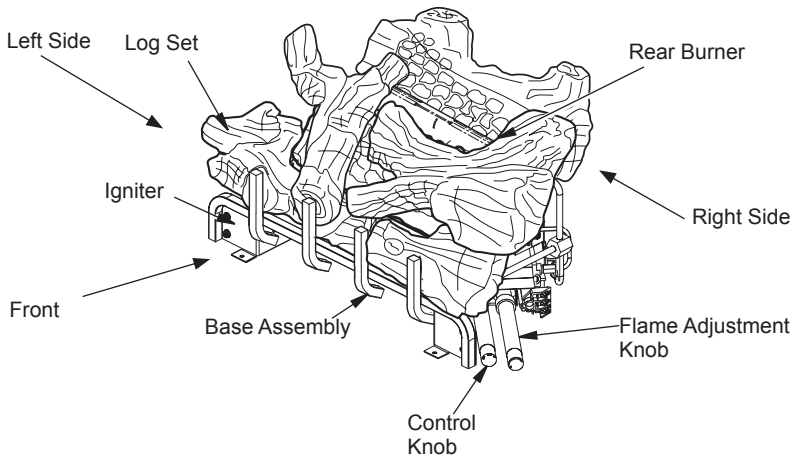

Figure 1 - Product Identification

LOCAL CODES

Install and use appliance with care. Follow all local codes. In the absence of local codes, use the latest edition of *The National Fuel Gas Code, ANSI Z223.1/NFPA 54**.

*Available from:

American National Standards Institute, Inc.
25 West 43rd Street, 4th floor
New York, NY 10036

National Fire Protection Association, Inc.
1 Batterymarch Park
Quincy, MA 02169-7471

UNPACKING

1. Remove logs and appliance base assembly from carton(s).

NOTE: Do not pick up appliance base assembly by burners. This could damage the appliance. Always handle base assembly by grate.

2. Remove all protective packaging applied to logs and appliance for shipment.
3. Check appliance for any shipping damage. If appliance is damaged, promptly inform dealer where you purchased the appliance.

⚠ CAUTION: Do not remove the data plates from the grate assembly. The data plates contain important warranty and safety information.

COMMONWEALTH OF MASSACHUSETTS REQUIREMENTS

These appliances are approved for installation in the US state of Massachusetts if the following additional requirements are met:

- Un-vented Room Heaters shall be installed in accordance with 527 CMR 30.
- Installation and repair must be done by a plumber or gas fitter licensed in the Commonwealth of Massachusetts.
- The flexible gas line connector used shall not exceed 36 inches (92 centimeters) in length.
- The individual manual shut-off must be a T-handle type valve.
- Unvented appliances may NOT be installed in bedrooms or bathrooms.
- A working smoke detector must be installed in the area where vent-free appliances are installed.

Seller of unvented propane or natural gas-fired supplemental room heaters shall provide to each purchaser a copy of 527 CMR 30 upon sale of the unit.

PRODUCT FEATURES

OPERATION

This heater is clean burning. It requires no outside venting. There is no heat loss out a vent or up a chimney. Heat is generated by both realistic flames and glowing coals. This heater is designed for vent-free operation with flue damper closed. It has been tested and approved to ANSI Z21.11.2 standard for unvented heaters. State and local codes in some areas prohibit the use of vent-free heaters. This heater may also be operated as a vented decorative (ANSI Z21.60) product by opening the flue damper.

AIR FOR COMBUSTION AND VENTILATION

⚠ WARNING: This heater shall not be installed in a room or space unless the required volume of indoor combustion air is provided by the method described in the National Fuel Gas Code, ANSI Z223.1/NFPA 54, the International Fuel Gas Code, or applicable local codes. Read the following instructions to ensure proper fresh air for this and other fuel-burning appliances in your home.

Today's homes are built more energy efficient than ever. New materials, increased insulation and new construction methods help reduce heat loss in homes. Homeowners apply weather strip and caulk around windows and doors to keep the cold air out and the warm air in. During heating months, homeowners want their homes as airtight as possible.

While it is good to make your home energy efficient, your home needs to breathe. Fresh air must enter your home. All fuel-burning appliances need fresh air for proper combustion and ventilation.

Exhaust fans, some fireplaces, clothes dryers and some fuel-burning appliances draw air from the house to operate. You must provide adequate fresh air for these appliances. This will ensure proper venting of vented fuel-burning appliances.

PROVIDING ADEQUATE VENTILATION

The following are excerpts from *National Fuel Gas Code, ANSI Z223.1/NFPA 54, Air for Combustion and Ventilation*.

All spaces in homes fall into one of the three following ventilation classifications:

SAFETY DEVICE

This heater has a pilot with an Oxygen Depletion Sensing (ODS) safety shutoff system. The ODS/pilot is a required feature for vent-free room heaters. The ODS/pilot shuts off the heater if there is not enough fresh air.

ELECTRONIC IGNITION SYSTEM

This heater has an electronic igniter to light heater fuel supply.

1. Unusually Tight Construction
2. Unconfined Space
3. Confined Space

The information on **Pages 6-8** will help you classify your space and provide adequate ventilation.

Unusually Tight Construction

The air that leaks around doors and windows may provide enough fresh air for combustion and ventilation. However, in buildings of unusually tight construction, you must provide additional fresh air.

Unusually tight construction is defined as construction where:

- a. **walls and ceilings exposed to the outside atmosphere have a continuous water vapor retarder with a rating of one perm (6×10^{-11} kg per pa-sec- m^2) or less with openings gasketed or sealed and**
- b. **weather stripping has been added on openable windows and doors and**
- c. **caulking or sealants are applied to areas such as joints around window and door frames, between sole plates and floors, between wall-ceiling joints, between wall panels, at penetrations for plumbing, electrical and gas lines and at other openings.**

If your home meets all three criteria above, you must provide additional fresh air. See Ventilation Air From Outdoors, Page 8.

If your home does not meet all three criteria above, proceed to Determining Fresh-Air Flow For Heater Location, below.

Confined and Unconfined Space

The *National Fuel Gas Code, ANSI Z223.1/NFPA54* allows two methods for determining whether the space in which the heater is being

AIR FOR COMBUSTION AND VENTILATION

Continued

installed is confined or unconfined space. The standard method defines a confined space as a space whose volume is less than 50 cubic feet per 1,000 Btu/hr (4.8 m³ per kw) of the aggregate input rating of all appliances installed in that space and an unconfined space as a space whose volume is not less than 50 cubic feet per 1,000 Btu/hr (4.8 m³ per kw) of the aggregate input rating of all appliances installed in that space. Rooms communicating directly with the space in which the appliances are installed*, through openings not furnished with doors, are considered a part of the unconfined space.

Where the air infiltration rate of a structure is known, the Known Air Infiltration Rate Method may be used. Follow The National Fuel Gas Code, ANSI Z223.1/NFPA 54 to use this method to determine if the space is confined or unconfined.

* Adjoining rooms are communicating only if there are doorless passageways or ventilation grills between them.

DETERMINING FRESH-AIR FLOW FOR HEATER LOCATION

Determining if You Have a Confined or Unconfined Space Using the Standard Method

Use this work sheet to determine if you have a confined or unconfined space.

Space: Includes the room in which you will install fireplace plus any adjoining rooms with doorless passageways or ventilation grills between the rooms.

- Determine the volume of the space (length x width x height).

Length x Width x Height = _____ cu. ft.
(volume of space)

Example: Space size 20 ft. (length) x 16 ft. (width) x 8 ft. (ceiling height) = 2560 cu. ft.
(volume of space)

If additional ventilation to adjoining room is supplied with grills or openings, add the volume of these rooms to the total volume of the space.

- Multiply the space volume by 20 to determine the maximum Btu/Hr the space can support.

_____ (volume of space) x 20 = (Maximum Btu/Hr the space can support)

Example: 2560 cu. ft. (volume of space) x 20 = 51,200 (maximum Btu/Hr the space can support)

- Add the Btu/Hr of all fuel burning appliances in the space.

Vent-free fireplace	_____ Btu/Hr
Gas water heater*	_____ Btu/Hr
Gas furnace	_____ Btu/Hr
Vented gas heater	_____ Btu/Hr
Gas fireplace logs	_____ Btu/Hr
Other gas appliances*	+ _____ Btu/Hr
Total	= _____ Btu/Hr

* Do not include direct-vent gas appliances. Direct-vent draws combustion air from the outdoors and vents to the outdoors.

Example:

Gas water heater	_____ 40,000 Btu/Hr
Vent-free fireplace	+ _____ 33,000 Btu/Hr
Total	= _____ 73,000 Btu/Hr

- Compare the maximum Btu/Hr the space can support with the actual amount of Btu/Hr used.

_____ Btu/Hr (maximum can support)

_____ Btu/Hr (actual amount used)

Example: 51,200 Btu/Hr (maximum the space can support)

73,000 Btu/Hr (actual amount of Btu/Hr used)

The space in the above example is a confined space because the actual Btu/Hr used is more than the maximum Btu/Hr the space can support. You must provide additional fresh air. Your options are as follows:

- Rework worksheet, adding the space of an adjoining room. If the extra space provides an unconfined space, remove door to adjoining room or add ventilation grills between rooms. See Ventilation Air From Inside Building, Page 8.
- Vent room directly to the outdoors. See Ventilation Air From Outdoors, Page 8.
- Install a lower Btu/Hr fireplace, if lower Btu/Hr size makes room unconfined.

If the actual Btu/Hr used is less than the maximum Btu/Hr the space can support, the space is an unconfined space. You will need no additional fresh air ventilation.

AIR FOR COMBUSTION AND VENTILATION

Continued

⚠ WARNING: If the area in which the heater may be operated does not meet the required volume for indoor combustion air, combustion and ventilation air shall be provided by one of the methods described in the National Fuel Gas Code, ANSI Z223.1/NFPA 54, the International Fuel Gas Code, or applicable local codes.

VENTILATION AIR

Ventilation Air From Inside Building

This fresh air would come from an adjoining unconfined space. When ventilating to an adjoining unconfined space, you must provide two permanent openings: one within 12" of the ceiling and one within 12" of the floor on the wall connecting the two spaces (see options 1 and 2, **Figure 2**). You can also remove door into adjoining room (see option 3, **Figure 2**). Follow the *National Fuel Gas Code, ANSI Z223.1/NFPA 54, Air for Combustion and Ventilation* for required size of ventilation grills or ducts.

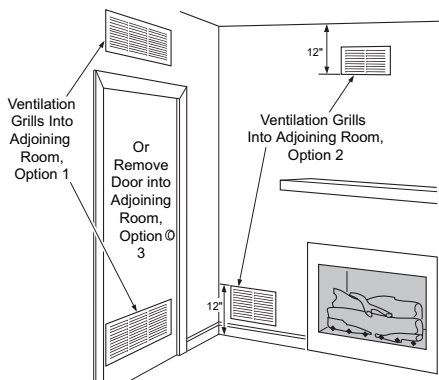

Figure 2 - Ventilation Air from Inside Building

Ventilation Air From Outdoors

Provide extra fresh air by using ventilation grills or ducts. You must provide two permanent openings: one within 12" of the ceiling and one within 12" of the floor. Connect these items directly to the outdoors or spaces open to the outdoors. These spaces include attics and crawl spaces. Follow the *National Fuel Gas Code, ANSI Z223.1/NFPA 54, Air for Combustion and Ventilation* for required size of ventilation grills or ducts.

IMPORTANT: Do not provide openings for inlet or outlet air into attic if attic has a thermostat-controlled power vent. Heated air entering the attic will activate the power vent.

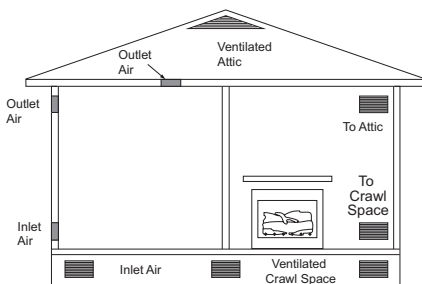

Figure 3 - Ventilation Air from Outdoors

INSTALLATION

NOTICE: This appliance is intended for supplemental heating. Use this heater along with your primary heating system. Do not install this heater as your primary heat source. If you have a central heating system, you may run system's circulating blower while using heater. This will help circulate the heat throughout the house. In the event of a power outage, you can use this heater as your primary heat source.

⚠ WARNING: A qualified service person must install heater. Follow all local codes.

NOTICE: State or local codes may only allow operation of this appliance in a vented configuration. Check your state or local codes.

⚠ WARNING: Before installing in a solid fuel burning fireplace, the chimney flue and firebox must be cleaned of soot, creosote, ashes and loose paint by a qualified chimney cleaner. Creosote will ignite if highly heated. A dirty chimney flue may create and distribute soot within the house. Inspect chimney and firebox flue for damage. If damaged, repair flue and firebox before operating heater.

⚠ WARNING: Any outside air ducts and/or ash dumps in the fireplace shall be permanently closed at time of appliance installation.

⚠ WARNING: Seal any fresh air vents or ash clean-out doors located on floor or wall of fireplace. If not, drafting may cause pilot outage or sooting. Use a heat-resistant sealant. Do not seal chimney flue damper.

⚠ WARNING: Never install the heater

- in a bedroom or bathroom unless installed as a vented appliance, see *Page 12*
- in a recreational vehicle
- where curtains, furniture, clothing or other flammable objects are less than 36" from the front and 42" from top heater, For side clearances see *Figure 4 Page 10*
- in high traffic areas
- in windy or drafty areas

⚠ CAUTION: This heater creates warm air currents. These currents move heat to wall surfaces next to heater. Installing heater next to vinyl or cloth wall coverings or operating heater where impurities (such as, but not limited to, tobacco smoke, aromatic candles, cleaning fluids, oil or kerosene lamps, etc.) in the air exist, may discolor walls or cause odors.

IMPORTANT: Vent-free heaters add moisture to the air. Although this is beneficial, installing heater in rooms without enough ventilation air may cause mildew to form from too much moisture. See *Air for Combustion and Ventilation, Page 6*.

INSTALLATION

Continued

CHECK GAS TYPE

Use the correct type of gas (natural or propane/ LP). If your gas supply is not the correct gas type, do not install appliance. Call the dealer where you purchased the appliance for proper type appliance.

⚠ WARNING: Do not allow fans to blow directly into the firebox. Avoid any drafts that alter burner flame patterns. Ceiling fans can create drafts that alter burner flame patterns. Altered burner patterns can cause sooting.

INSTALLATION AND CLEARANCES FOR VENT-FREE OPERATION

⚠ WARNING: Maintain the minimum clearances. If you can, provide greater clearances from floor, ceiling and adjoining wall.

Minimum Fireplace Clearance to Combustible Materials
Side Wall 16", Ceiling 42", Floor 5", Front 36"

LOG SIZING REQUIREMENTS				
Log Set Model No.	Minimum Firebox Size			
	Height	Depth	Front Width	Rear* Width
LBG18SM	17"	13.5"	20"	14"
LBG24SM	17"	13.5"	26"	18"
LBG30SM	21"	13.5"	32"	22"
LBG36SM	21"	13.5"	38"	27.5"
LBG18BM	17"	14.5"	26"	20"
LBG24BM	17"	14.5"	29"	22"
LBG30BM	21"	14.5"	32"	22"

Carefully follow these instructions. This will ensure safe installation into a masonry, UL127-listed manufactured fireplace or listed vent-free firebox.

Minimum Clearances For Side Combustible Material, Side Wall and Ceiling

A. Clearances from the side of the fireplace cabinet to any combustible material and wall should follow diagram in **Figure 4**.

Example: The face of a mantel, bookshelf, etc. is made of combustible material and protrudes 3-1/2" from the wall. This combustible material must be 4" from the side of the fireplace cabinet (see **Figure 4**).

NOTE: When installing your gas logs into a manufactured firebox, follow firebox manufacturer's instructions for minimum clearances to combustible materials.

B. Clearances from the top of the fireplace opening to the ceiling should not be less than 42".

NOTICE: Manual control heaters may be used as a vented product. If so, you must always run heater with chimney flue damper open. If running heater with damper open, noncombustible material above fireplace opening is not needed. Go to Installing Damper Clamp Accessory for Vented Operation, Page 12.

Maintain adequate clearances for accessibility for purposes of servicing and proper operation.

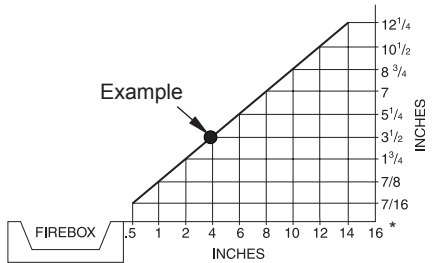

Figure 4 - Minimum Clearance for Combustible to Wall

INSTALLATION

Continued

Determining Minimum Mantel Clearance When Using a Hood

If minimum clearances in **Figure 6, Page 11**, are not met, you must have a hood. When using a hood there are still certain minimum mantel clearances required. Follow minimum clearances shown in **Figure 7**, when using hood.

NOTICE: Surface temperatures of adjacent walls and mantels become hot during operation. Walls and mantels above the firebox may become hot to the touch. If installed properly, these temperatures meet the requirement of the national product standard. Follow all minimum clearances shown in this manual.

Notice: If your installation does not meet the minimum clearances shown, you must do one of the following:

- operate the logs only with the flue damper open
- raise the mantel to an acceptable height
- remove the mantel

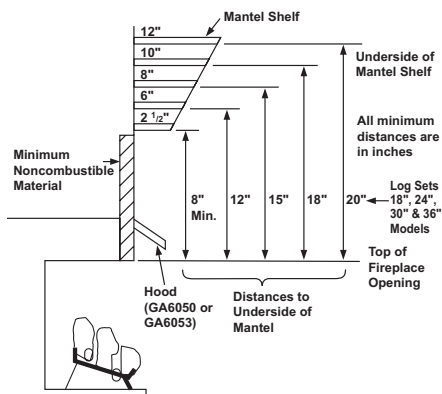

Figure 7 - Minimum Mantel Clearances When Using Hood

FLOOR CLEARANCES

- A. If installing appliance on the floor level, you must maintain the minimum distance of 14" to combustibles (see **Figure 8**).
- B. If combustible materials are less than 14" to the fireplace, you must install appliance at least 5" above the top surface of combustible flooring including tile and carpet (see **Figure 9**).

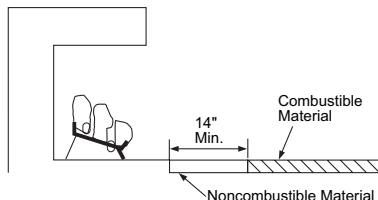

Figure 8 - Minimum Fireplace Clearances If Installed at Floor Level

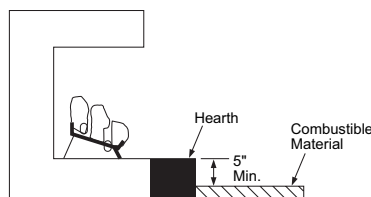

Figure 9 - Minimum Fireplace Clearances Above Combustible Flooring

INSTALLING DAMPER CLAMP ACCESSORY FOR VENTED OPERATION

NOTE: When used as a vented heater, appliance must be installed only in a solid-fuel burning fireplace with a working flue and constructed of noncombustible material.

For Massachusetts Residents Only: Installation of this gas log set as a vented appliance in the Commonwealth of Massachusetts requires the damper be permanently removed or welded in the fully open position.

If your heater is a manually-controlled model, you may use this heater as a vented product. There are three reasons for operating your heater in the vented mode.

INSTALLATION

Continued

1. The fireplace does not meet the clearance to combustibles requirements for vent-free operation.
2. State or local codes do not permit vent-free operation.
3. You prefer vented operation.

If reasons number 1 or 2 apply to you, you must permanently open chimney flue damper. You must install the damper clamp accessory (to order, see *Accessories, Page 34*). This will ensure vented operation (see *Figure 10*). The damper clamp will keep damper open. Installation instructions are included with clamp accessory.

See chart below for minimum permanent flue opening you must provide. Attach damper clamp so the minimum permanent flue opening will be maintained at all times.

Area of Various Standard Round Flues	
Diameter	Area
5"	20 sq. inches
6"	29 sq. inches
7"	39 sq. inches
8"	51 sq. inches

Chimney Height	Minimum Permanent Flue Opening
6' to 15'	39 sq. inches
15' to 30'	29 sq. inches

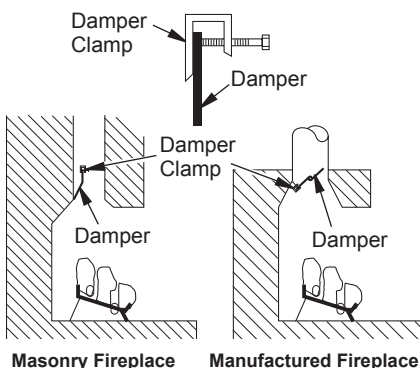

Figure 10 - Attaching Damper Clamp

INSTALLING HEATER BASE ASSEMBLY

⚠ WARNING: You must secure this heater to fireplace floor. If not, heater will move when you adjust controls. Moving heater may cause a gas leak.

⚠ WARNING: If installing in a sunken fireplace, special care is needed. You must raise the fireplace floor to allow access to heater control panel. This will ensure adequate air flow and guard against sooting and controls being damaged. Raise fireplace floor with noncombustible material. Make sure material is secure.

⚠ CAUTION: Do not pick up heater base assembly by burners. This could damage heater. Only handle base assembly by grates.

IMPORTANT: Make sure the heater burners are level. If heater is not level, heater will not work properly.

Installation Items Needed

- hardware package (provided with heater)
- approved flexible gas hose and fittings (if allowed by local codes)
- sealant (resistant to propane/LP gas, not provided)
- electric drill with 3/16" masonry drill bit

NOTE: Install optional Receiver and Hand-Held Remote Control Kit (see *Accessories, Page 34*) before installing gas log heater. See installation instructions included with the kit.

INSTALLATION

Continued

1. Apply pipe joint sealant lightly to male threads of gas fitting (provided). Connect approved flexible gas hose to inlet side of gas control (see **Figure 11**).
IMPORTANT: Hold gas regulator with wrench when connecting flexible gas hose.
2. Position heater base assembly in fireplace.
3. Mark screw locations through holes in front panel of base (see **Figure 12**). If installing in a brick-bottom fireplace, mark screw locations in mortar joint of bricks.
4. Remove heater base from fireplace.
5. Drill holes at marked locations using 3/16" drill bit.
6. Attach base, through holes in front panel of base, to fireplace floor using masonry screws provided in hardware package (see **Figure 12**).
7. Connect to gas supply. See Connecting To Gas Supply.

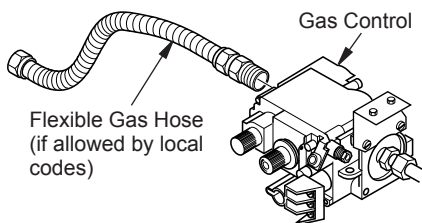

Figure 11 - Attaching Flexible Gas Hose to Heater Gas Regulator

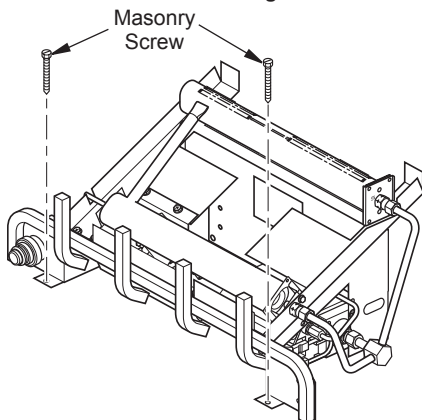

Figure 12 - Attaching Base to Fireplace Floor

CONNECTING TO GAS SUPPLY

⚠ WARNING: This appliance requires a 3/8" NPT (National Pipe Thread) inlet connection to the pressure regulator.

⚠ WARNING: A qualified service person must connect heater to gas supply. Follow all local codes.

⚠ CAUTION: Never connect propane/LP fireplace directly to the propane/LP supply. This heater requires an external regulator (not supplied). Install the external regulator between the heater and propane/LP supply.

⚠ WARNING: Never connect natural gas fireplace to private (non-utility) gas wells. This gas is commonly known as wellhead gas.

Installation Items Needed

Before installing heater, make sure you have the items listed below.

- external regulator (supplied by installer)
- piping (check local codes)
- sealant (resistant to propane/LP gas)
- equipment shutoff valve *
- test gauge connection *
- sediment trap
- tee joint
- pipe wrench
- approved flexible gas line with gas connector (if allowed by local codes)

* An equipment shutoff valve with 1/8" NPT tap is an acceptable alternative to test gauge connection. Purchase the optional equipment shutoff valve from your dealer.

INSTALLATION

Continued

For propane/LP units, the installer must supply an external regulator. The external regulator will reduce incoming gas pressure. You must reduce incoming gas pressure to between 11" and 14" of water. If you do not reduce incoming gas pressure, heater regulator damage could occur. Install external regulator with the vent pointing down as shown in **Figure 13**. Pointing the vent down protects it from freezing rain or sleet.

CAUTION: Use only new, black iron or steel pipe. Internally-tinned copper tubing may be used in certain areas. Check your local codes. Use pipe of 1/2" diameter or greater to allow proper gas volume to heater. If pipe is too small, undue loss of volume will occur.

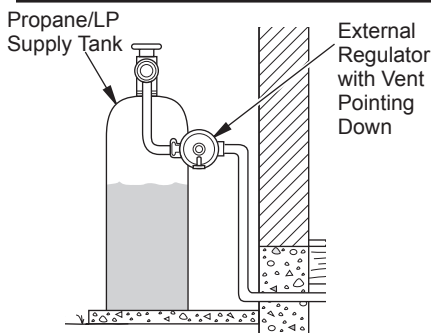

Figure 13 - External Regulator With Vent Pointing Down

Installation must include an equipment shutoff valve, union and plugged 1/8" NPT tap. Locate NPT tap within reach for test gauge hook up. NPT tap must be upstream from heater (see **Figure 14**).

IMPORTANT: Install equipment shutoff valve in an accessible location. The equipment shutoff valve is for turning on or shutting off the gas to the appliance.

Check your building codes for any special requirements for locating equipment shutoff valve to fireplaces.

Apply pipe joint sealant lightly to male NPT threads. This will prevent excess sealant from going into pipe. Excess sealant in pipe could result in clogged heater valves.

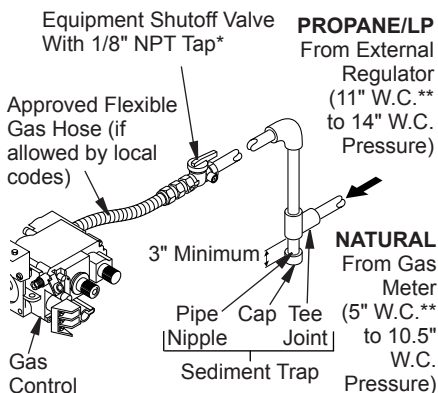

Figure 14 - Gas Connection

* Purchase the optional equipment shutoff valve from your dealer.

**Minimum inlet pressure for purpose of input adjustment.

WARNING: Use pipe joint sealant that is resistant to liquid petroleum (LP) gas.

We recommend that you install a sediment trap in supply line as shown in **Figure 14**. Locate sediment trap where it is within reach for cleaning. Install in piping system between fuel supply and heater. Locate sediment trap where trapped matter is not likely to freeze. A sediment trap traps moisture and contaminants. This keeps them from going into heater controls. If sediment trap is not installed or is installed wrong, heater may not run properly.

CAUTION: Avoid damage to gas control. Hold gas control with wrench when connecting it to gas piping and/or fittings.

INSTALLATION

Continued

CHECKING GAS CONNECTIONS

⚠ WARNING: Test all gas piping and connections, internal and external to unit, for leaks after installing or servicing. Correct all leaks at once.

⚠ WARNING: Never use an open flame to check for a leak. Apply a noncorrosive leak detection fluid to all joints. Bubbles forming show a leak. Correct all leaks at once.

⚠ CAUTION: Make sure external regulator has been installed between propane/LP supply and heater. See guidelines under Connecting to Gas Supply, Page 14.

PRESSURE TESTING GAS SUPPLY PIPING SYSTEM

Test Pressures In Excess Of 1/2 PSIG (3.5 kPa)

1. Disconnect appliance with its appliance main gas valve (control valve) and equipment shutoff valve from gas supply piping system. Pressures in excess of 1/2 psig (3.5 kPa) will damage heater regulator.
2. Cap off open end of gas pipe where equipment shutoff valve was connected.
3. Pressurize supply piping system by either opening propane/LP supply tank valve for propane/LP gas or opening main gas valve located on or near gas meter for natural gas or using compressed air.
4. Check all joints of gas supply piping system. Apply noncorrosive leak detection fluid to all joints. Bubbles forming show a leak.
5. Correct all leaks at once.
6. Reconnect heater and equipment shutoff valve to gas supply. Check reconnected fittings for leaks.

Test Pressures Equal To or Less Than 1/2 PSIG (3.5 kPa)

1. Close equipment shutoff valve (see *Figure 15*).
2. Pressurize supply piping system by either opening propane/LP supply tank valve for propane/LP gas or opening main gas valve located on or near gas meter for natural gas or using compressed air.
3. Check all joints from gas meter to equipment shutoff valve for natural gas or propane/LP supply to equipment shutoff valve for propane/LP (see *Figure 16 or 17*). Apply noncorrosive leak detection fluid to all joints. Bubbles forming show a leak.
4. Correct all leaks at once.

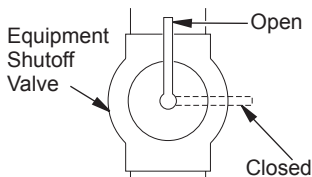

Figure 15 - Equipment Shutoff Valve

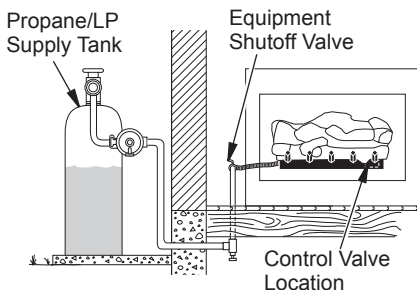

Figure 16 - Checking Gas Joints (Propane/LP Only)

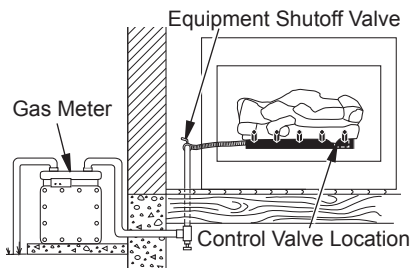

Figure 17 - Checking Gas Joints (Natural Gas Only)

INSTALLATION

Continued

PRESSURE TESTING HEATER GAS CONNECTIONS

1. Open equipment shutoff valve (see *Figure 15, Page 16*).
2. Open main gas valve located on or near gas meter for natural gas or open propane/LP supply tank valve.
3. Make sure control knob of heater is in the OFF position.
4. Check all joints from equipment shutoff valve to gas valve (see *Figure 16 or 17*). Apply noncorrosive leak detection fluid to all joints. Bubbles forming show a leak.
5. Correct all leaks at once.
6. Light heater (see *Operation, Page 24 depending on your model*). Check all other internal joints for leaks.
7. Turn off heater (see *To Turn Off Gas to Appliance, Page 25*, depending on your model).

INSTALLING LOGS

WARNING: Failure to position the parts in accordance with these diagrams or failure to use only parts specifically approved with this heater may result in property damage or personal injury.

BGE Series Burner System - Log Compatibility Chart		
Burner System Models	Fiber Log Models	Concrete Log Models
BGE18NR, BGE18PR	LBG18SM	LBG18BM
BGE2436NR, BGE2436PR	LBG24SM LBG30SM LBG36SM	LBG24BM LBG30BM

Log Support Brackets

If installing a LBG36SM, attach log support brackets before installing logs. These brackets are provided with the BG(E)2436 series burner systems.

1. Install left bracket to left side of chassis using 2 screws provided (see *Figure 18*).
2. Install right bracket to right front of chassis using 2 screws provided (see *Figure 18*). This bracket will also be used as remote control bracket if remote is installed.

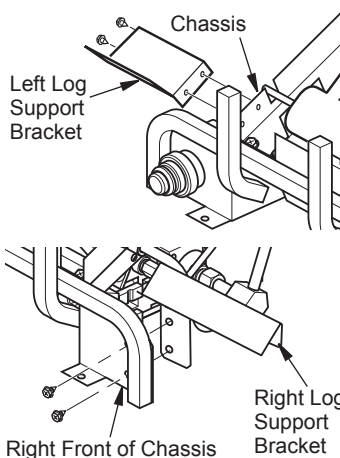

Figure 18 - Installing Log Support Brackets

INSTALLING SWITCH

A AUTO/OFF/ON switch and wire assembly is supplied with this burner system. This switch needs to be used only if remote or wall switch is not being used. Place the wire assembly and switch into the switch log. Remove the jumper wire from the control valve and then connect the wires to the valve from the switch assembly as shown in *Figure 19*.

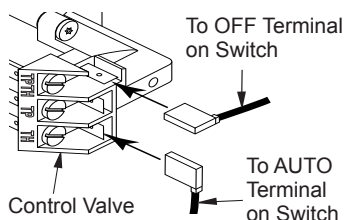

Figure 19 - Connecting Wires

INSTALLATION

Continued

FIBER LOG MODELS

LBG(18,24,30,36)SM

NOTE: Your appliance may vary from model shown but log placement will be the same.

1. Place bottom log in center of the base assembly as shown in **Figure 21**. The log must sit flat on the black metal sheet and behind the left metal tab as shown in **Figure 20**.

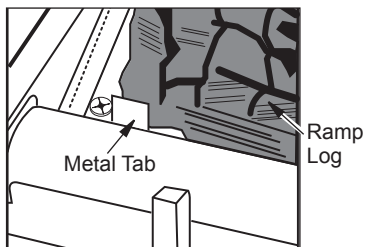

Figure 20 - Installing Log Set

2. Rest rear log in back corner sections of base assembly as shown in **Figure 21**. Make sure log is completely vertical and not leaning in toward burner where flame will touch the log.
3. Position front right log against right side of grate prongs (see **Figure 21**).
4. Position front left log against left side of grate prongs (see **Figure 21**).

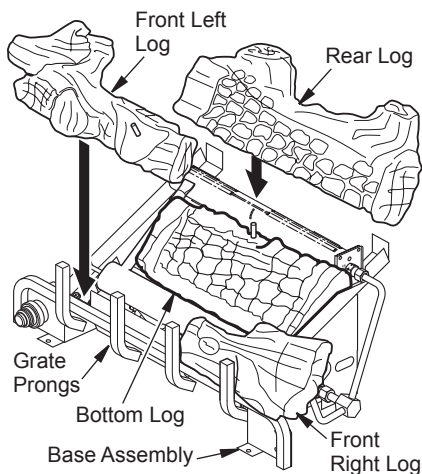

Figure 21 - Installing Log Set

5. Place middle right log over front right and bottom logs as shown in **Figure 22**. Be sure hole in middle right log seats over pin in bottom log.
6. Place middle left log over front left and bottom logs as show in **Figure 22**. Be sure hole in middle left log seats over pin in front left log.

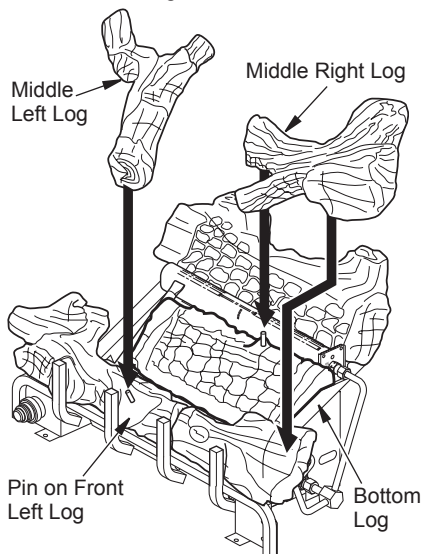

Figure 22 - Installing Log Sets

7. For LTF36SM, the front right and left logs are longer and are supported with brackets on each end (see **Figure 23**). Place left and right small front logs under left bracket and beside right bracket.

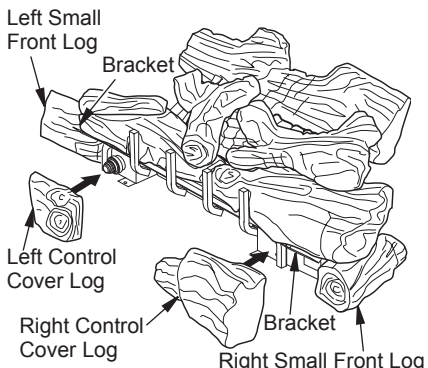

Figure 23 - Installing LBG36SM Model Control Cover Logs

INSTALLATION

Continued

- For LBG36SM, position left and right control cover logs as shown in **Figure 24**. These may be placed as desired to hide controls.



LBG(18,24,30)SM MODELS



LBG36SM MODELS

Figure 24 - Correct Log Placement

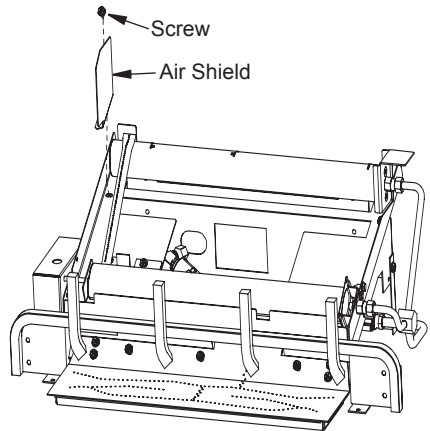

Figure 25 - Removing Air Shield

CONCRETE LOG MODELS LBG (18,24,30) BM

NOTE: Your appliance may vary from model shown but log placement will be the same.

- Before placing any logs on the chassis you will need to remove the Air Shield located on the left side near the rear burner as shown in **Figure 25**. The Air Shield is held in place with one screw, remove the Air Shield and place the screw back into the hole in the chassis. Place the Air Shield with your owner's manual and keep.
- Place fiber ramp log in center of chassis as shown in **Figure 26**. The fiber ramp log can be identified by the shape and much lighter weight when compared to the other logs. The log must sit flat on the black sheet metal and behind the left metal tab as shown. Make sure the side marked "BOTTOM" is setting down.
- Place front left (18" D-064, 24" D-057 & 30" D-038) and front right (18" D-065, 24" D-058 & 30" D-039) logs as shown in **Figure 27**.

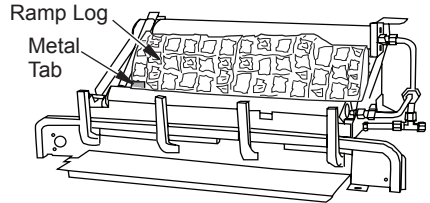

Figure 26 - Installing Fiber Ramp Log

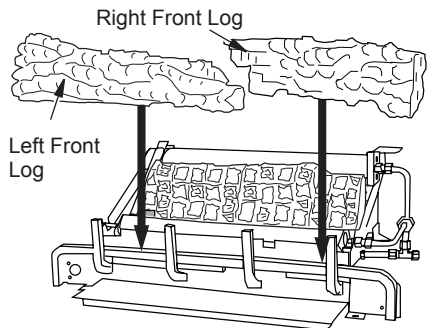

Figure 27 - Installing Left/Right Front Logs

INSTALLATION

Continued

4. Place left ember bed log (18" D-073, 24" & 30" D-048) as shown in **Figure 28**. The log has groove on one side that sets on the ember bed pan. The back side of this log needs to rest against the front of the base assembly. Make sure the flame from the ember pan does not touch the ember bed log.

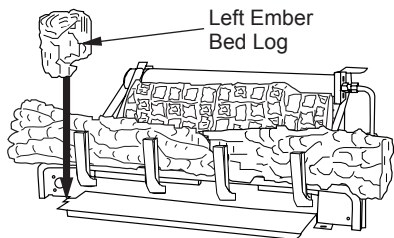

Figure 28 - Installing Left Ember Bed Log

5. The right ember bed log 24" & 30" (D-047) has a hole in the log that sets on the grate finger and the other end rest on the fireplace floor, place log as shown in **Figure 29**. The right ember bed logs for 18" (D-072) has a groove on the side that sets on the ember bed pan and the back of the log needs to rest against the front of the base. Make sure the flame from the ember pan does not touch the ember bed log. The back side of this log needs to rest against the front of the base assembly, make sure the flame from the ember pan does not touch the ember bed log.

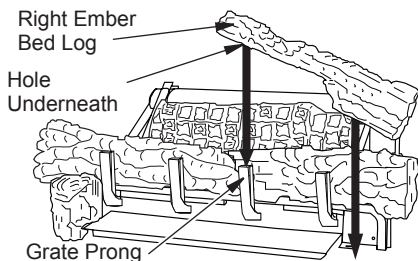

Figure 29 - Installing Right Ember Bed Log

6. The left middle log (18" D-066, 24" & 30" D-040) has a groove on the bottom to sit on the chassis and has to sit on the tab on the back of the left front log as shown in **Figure 30**.

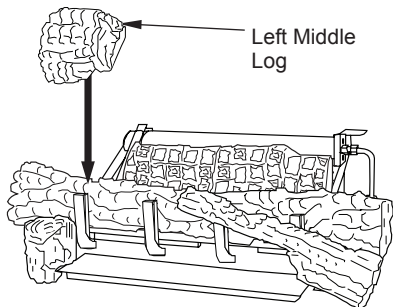

Figure 30 - Installing Left Middle Log

7. The right middle log (18" D-067, 24" & 30" D-041) has a groove on the bottom to sit on the chassis and has to sit on the tab on the back of the right front. The right middle log should have a recess area that fits around the ramp log as shown in **Figure 31**.

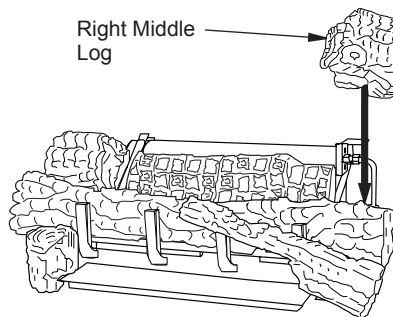

Figure 31 - Installing Right Middle Log

INSTALLATION

Continued

8. The rear middle log (18" D-068, 24" & 30" D-042) should fit between the ramp log and the rear burner. The left and right middle logs have recessed areas for the rear middle log to sit into (See **Figure 32**). There may be a small gap between the rear middle log and the ramp log, this is normal.. Be careful not to push the rear burner out of position while installing this log.

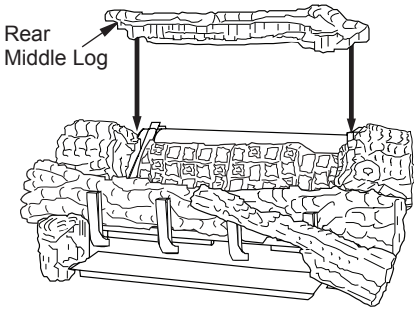

Figure 32 - Installing Rear Middle Log

9. Rest the rear log (18" D-069, 24" & 30" D-043) on the chassis behind the rear burner as shown in **Figure 33**. The bottom of the rear log will sit into the rear log supports.

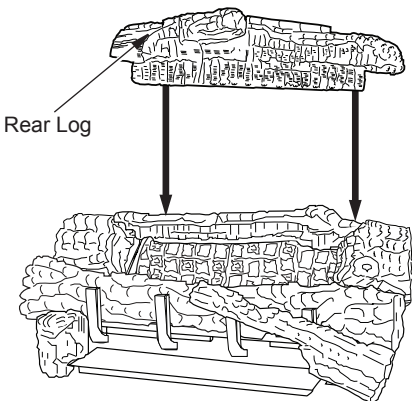

Figure 33 - Installing Rear Log

10. Place the left top log (D-046) onto the rear log and the left middle log. Make sure to place the projection on the bottom of the left top log into the recessed areas on the rear and left middle logs (see **Figure 34**).

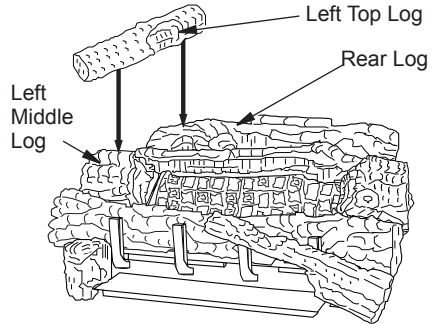

Figure 34 - Installing Left Top Log

11. Rest the middle crossover log (18" D-070, 24" & 30" D-044) onto the right middle log and the left front log (see **Figure 35**). Make sure to match the projection on the bottom of the crossover log with the recess area in the right middle log and the left front log.

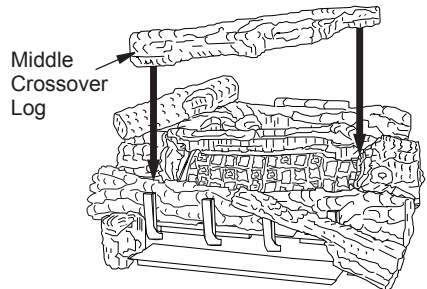

Figure 35 - Installing Middle Crossover Log

INSTALLATION

Continued

- Place the top rear log (18" D-071, 24" & 30" D-045) onto the rear log as shown. The rear log has a projection that will fit into the recess area on the bottom of the top rear log (see *Figure 36*).

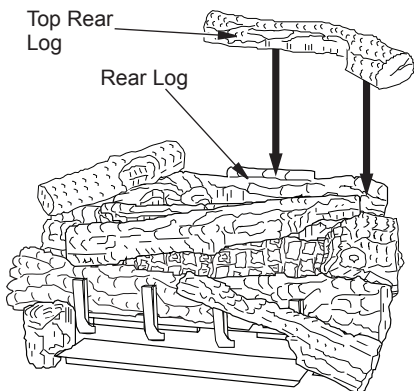

Figure 36 - Installing Top Rear Log

EMBER PLACEMENT - BGE SERIES BURNER SYSTEMS

WARNING: Do not operate unit without ember material correctly in place as shown in *Figures 38 & 39*. Do NOT place ember material anywhere else on the unit. Use only ember material supplied with unit. Excessive or incorrectly placed ember material may produce carbon monoxide or soot. If replacement embers are needed, the replacement embers must be purchased from IHP. See *Page 37* for part numbers.

WARNING: Do not use any other ember material not supplied with this unit.

WARNING: All previously applied loose material must be removed prior to reapplication.

If replacement embers are needed, the replacement embers must be purchased from IHP. See *Page 37* for part numbers.

- Ember Chunk Placement.** The BGE2436 burner systems include three ember chunks that are designed to fit over shoulder screws on the ember pan burner. The bottom of each ember chunk has a hole for securing the ember chunk in place when it is placed over a shoulder screw. Place the ember chunks as shown in *Figure 37* on *Page 23* by placing the ember chunk with the number "1" on the left, "2" in the center, and "3" on the right. These numbers are embossed on the back of each piece for identification purposes. Please note that BGE18 burner systems do not include ember chunks.
- Two ember materials are supplied with this log set. Platinum Bright Embers give a bright glow appearing as hot coals. Follow instructions for the ember material you choose. Should embers need replacing, see *Parts, Page 37*.
Platinum Bright Ember placement. Add embers to front, flat burner. Gently remove embers from bag. Separate pieces of ember material and place on surface of flat burner just behind horizontal ports as shown in *Figure 38*.
Glowing Embers (rockwool) placement. Place glowing ember material on front flat burner in areas away from ports as shown in *Figure 39*.
- Add volcanic stone and small decorative logs around base of heater if desired. **DO NOT place volcanic stone or additional logs on front burner or on logs.** Placing any material on unit other than ember material on front burner may result in production of carbon monoxide or soot. Use volcanic stone to hide wires from switch/log to control valve. Place switch/log so the switch is easy to access.

INSTALLATION

Continued

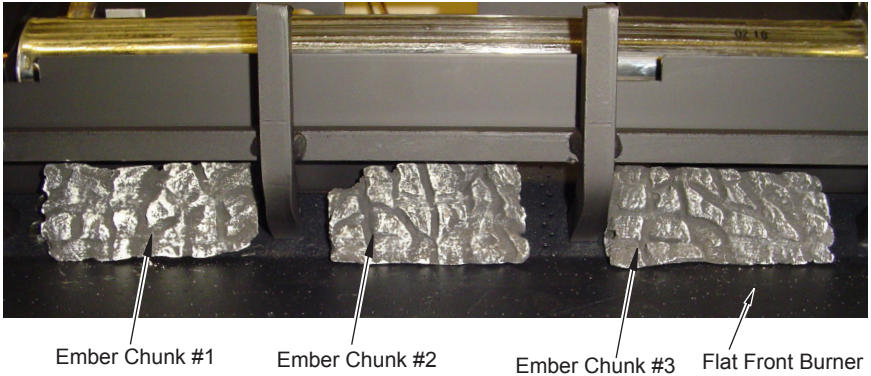
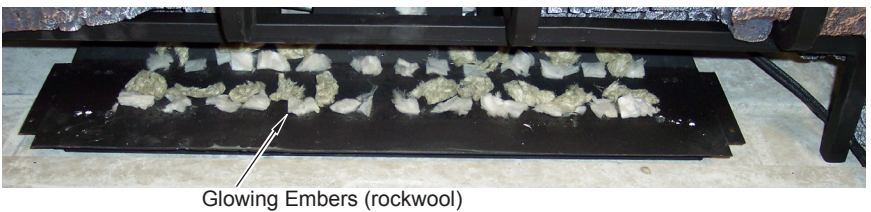

Figure 37 - Ember Chunk Placement BGE2436 Series



Figure 38 - Platinum Bright Embers for BGE Series



**Figure 39 - Placement of Glowing Embers for BGE Series
(shown with Platinum Bright Embers)**

OPERATION

FOR YOUR SAFETY READ BEFORE LIGHTING

WARNING: If you do not follow these instructions exactly, a fire or explosion may result causing property damage, personal injury or loss of life.

- A. This appliance has a pilot which must be lighted by hand. When lighting the pilot, follow these instructions exactly.
- B. **BEFORE LIGHTING** smell all around the appliance area for gas. Be sure to smell next to the floor because some gas is heavier than air and will settle on the floor.

WHAT TO DO IF YOU SMELL GAS

- Do not try to light any appliance.
 - Do not touch any electric switch; do not use any phone in your building.
 - Immediately call your gas supplier from a neighbor's phone. Follow the gas supplier's instructions.
 - If you cannot reach your gas supplier, call the fire department.
- C. Use only your hand to push in or turn the gas control knob. Never use tools. If the knob will not push in or turn by hand, don't try to repair it, call a qualified service technician or gas supplier. Force or attempted repair may result in a fire or explosion.
 - D. Do not use this appliance if any part has been under water. Immediately call a qualified service technician to inspect the appliance and to replace any part of the control system and any gas control which has been under water.

LIGHTING INSTRUCTIONS

NOTICE: During initial operation of new heater, burning logs will give off a paper-burning smell. Orange flame will also be present. Open damper or window to vent smell. This will only last a few hours.

WARNING:

- If fireplace has glass doors, never operate this heater with glass doors closed. If you operate heater with doors closed, heat buildup inside fireplace will cause glass to burst. Make sure there are no obstructions across openings of fireplace.
- You must operate this heater with a fireplace screen in place. Make sure fireplace screen is closed before running heater.

NOTE: Homeowners generally prefer to operate their heater with the chimney damper closed. This will put all the heat into the room. However, there may be times you will desire the full flames of the HI heat setting but will find the heat output excessive. You can open the chimney damper (if you have one) fully or partially to release some of the heat.

WARNING: Damper handle will be hot if heater has been running.

1. STOP! Read the safety information.
2. Make sure equipment shutoff valve is fully open.
3. Press in and turn control knob clockwise to the OFF position (see **Figure 40**).

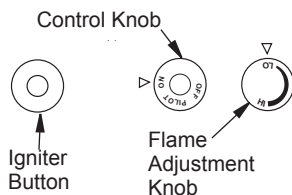



Figure 40 - Control Knob and Igniter Button Location

OPERATION

Continued

WARNING: Burners will come on automatically within one minute when the selector switch is in the ON position after the pilot is lit.

- Wait five (5) minutes to clear out any gas. Then smell for gas, including near the floor. If you smell gas, STOP! Follow B in the safety information, **Page 24**. If you don't smell gas, go to the next step.
- Press in and turn control knob counterclockwise  to the PILOT position. Press in control knob for five (5) seconds (see **Figure 40, Page 24**).

NOTE: You may be running this heater for the first time after hooking up to gas supply. If so, the control knob may need to be pressed in for 30 seconds or less. This will allow air to bleed from the gas system.



- With control knob pressed in, press and release igniter button. This will light pilot. The pilot is attached to the front burner. If needed, keep pressing igniter button until pilot lights.

NOTE: If pilot does not stay lit, contact a qualified service person or gas supplier for repairs. Until repairs are made, light pilot with match. To light pilot with match, see **Manual Lighting Procedure**.

- Keep control knob pressed in for 30 seconds after lighting pilot. After 30 seconds, release control knob.

• If control knob does not pop out when released, contact a qualified service person or gas supplier for repairs.

NOTE: If pilot goes out, repeat steps 4 through 8.

- Slightly push in and turn control knob counterclockwise  to the ON position.
- Set flame adjustment knob to any level between HI and LO.
- You may shut off the burners and keep the pilot lit by doing one of the following:
 - Turn control knob clockwise  to the PILOT position.
 - Use remote control manual OFF button.

CAUTION: Do not try to adjust heating levels by using the equipment shutoff valve.

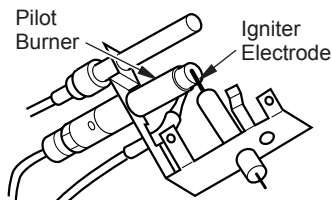

Figure 41 - Pilot (Propane/LP)

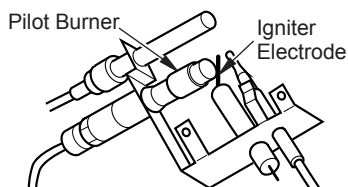



Figure 42 - Pilot (Natural)

TO TURN OFF GAS TO APPLIANCE

- Turn control knob clockwise  to the OFF position.
- If Using Optional Hand-Held Remote:** Set selector switch in the OFF position to prevent draining battery.
- Close equipment shutoff valve (see **Figure 16 or 17, Page 16**).

MANUAL LIGHTING PROCEDURE

- Follow steps 1 through 6 under **Lighting Instructions, Page 24**.
- Depress control knob and light pilot with match.
- Keep control knob pressed in for 30 seconds after lighting pilot. After 30 seconds, release control knob. Now follow steps 9 through 11, **Lighting Instructions, Page 25**.

INSPECTING BURNERS

Check pilot flame pattern and burner flame patterns often.

PILOT FLAME PATTERN

Figure 43 shows a correct pilot flame pattern. **Figure 44** shows an incorrect pilot flame pattern. The incorrect pilot flame is not touching the thermocouple. This will cause the thermocouple to cool. When the thermocouple cools, the heater will shut down.

If pilot flame pattern is incorrect, as shown in **Figure 44**.

- turn heater off (see To Turn Off Gas to Appliance, Page 25).
- see Troubleshooting, Page 29

NOTE: The pilot flame on natural gas units will have a slight curve, but flame should be blue and have no yellow or orange color.

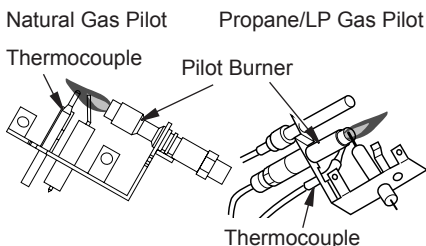

Figure 43 - Correct Pilot Flame Pattern
(Your pilot may vary from pilots shown)

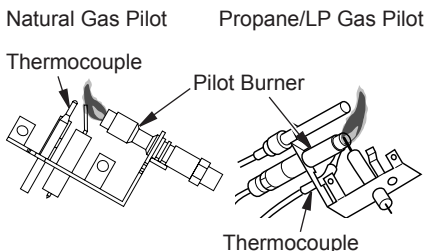

Figure 44 - Incorrect Pilot Flame Pattern
(Your pilot may vary from pilots shown)

BURNER FLAME PATTERN

Figure 45 shows correct burner flame pattern. **Figure 46** shows incorrect burner flame pattern.

WARNING: If incorrect burner flame occurs, your heater could produce increased levels of carbon monoxide.

NOTICE: Do not mistake orange flames with yellow tipping. Dirt or other fine particles are burned by heater, causing brief patches of orange flame.

Middle burner flame should be blue with the ramp/log glowing orange/red

Bright yellow rear burner flame; flame will be blue next to the burner

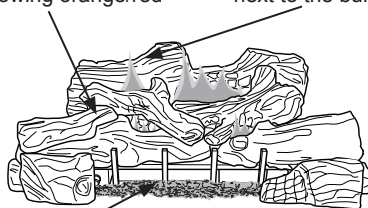

Small blue flame on ember burner with no yellow tipping

Figure 45 - Correct Burner Flame Pattern

If front burner flame pattern is incorrect, as shown in **Figure 46**.

- turn heater off (see To Turn Off Gas to Appliance, Page 25)
- see Troubleshooting, Page 29

Yellow tipping on ember burner

Dark orange rear burner flame

Yellow or dark orange middle burner flame



Figure 46 - Incorrect Burner Flame Pattern

CLEANING AND MAINTENANCE

⚠ WARNING: Turn off heater and let cool before cleaning.

⚠ CAUTION: You must keep control areas, burners and circulating air passageways of heater clean. Inspect these areas of heater before each use. Have heater inspected yearly by a qualified service person. Heater may need more frequent cleaning due to excessive lint from carpeting, pet hair, bedding material, etc.

⚠ WARNING: Failure to keep the primary air opening(s) of the burner(s) clean may result in sooting and property damage.

BURNER ORIFICE HOLDER AND PILOT AIR INLET HOLE

The primary air inlet holes allow the proper amount of air to mix with the gas. This provides a clean burning flame. Keep these holes clear of dust, dirt, lint and pet hair. Clean these air inlet holes prior to each heating season. Blocked air holes will create soot. We recommend that you clean the unit every three months during operation and have heater inspected yearly by a qualified service person.

We also recommend that you keep the burner tube and pilot assembly clean and free of dust and dirt. To clean these parts we recommend using compressed air no greater than 30 PSI. Your local computer store, hardware store or home center may carry compressed air in a can. If using compressed air in a can, please follow the directions on the can. If you don't follow directions on the can, you could damage the pilot assembly.

1. Shut off unit, including pilot. Allow unit to cool for at least thirty minutes.
2. Inspect burner, pilot and primary air inlet holes on orifice holder for dust and dirt (see *Figure 47*).
3. Blow air through the ports/slots and holes in the burner.
4. Check orifice holder located at the end of the burner tube again. Remove any large particles of dust, dirt, lint or pet hair with a soft cloth or vacuum cleaner nozzle.

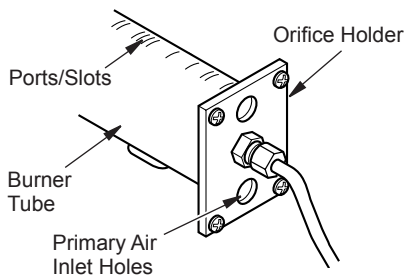

Figure 46 - Orifice Holder On Outlet Burner Tube

CLEANING AND MAINTENANCE

Continued

5. Blow air into the primary air holes on the orifice holder.
6. In case any large clumps of dust have now been pushed into the burner repeat steps 3 and 4, beginning on **Page 27**.

Clean pilot assembly also. A yellow tip on the pilot flame indicates dust and dirt in the pilot assembly. There is a small pilot air inlet hole about 2" from where the pilot flame comes out of the pilot assembly (see **Figure 48**). With the unit off, lightly blow air through the air inlet hole. You may blow through a drinking straw if compressed air is not available.

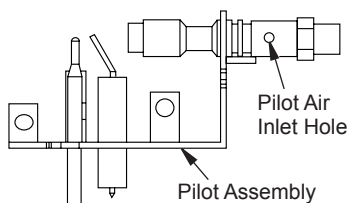

Figure 47 - Pilot Inlet Air Hole (Your pilot may vary from pilot shown)

LOGS

- If you remove logs for cleaning, refer to *In-stalling Logs*, **Page 17**, to properly replace logs.
- Replace log(s) if broken or chipped (dime-sized or larger).

MAIN BURNER

Periodically inspect all burner flame holes with the heater running. All slotted burner flame holes should be open with yellow flame present. All round burner flame holes should be open with a small blue flame present. Some burner flame holes may become blocked by debris or rust, with no flame present. If so, turn off heater and let cool. Remove blockage, blocked burner flame holes will create soot.

TROUBLESHOOTING

⚠ WARNING: Turn off heater and let cool before servicing. Only a qualified service person should service and repair heater.

⚠ CAUTION: Never use a wire, needle or similar object to clean ODS/pilot. This can damage ODS/pilot unit.

NOTE: All troubleshooting items are listed in order of operation.

OBSERVED PROBLEM	POSSIBLE CAUSE	REMEDY
When igniter button is pressed, there is no spark at ODS/pilot	<ol style="list-style-type: none"> 1. Igniter electrode not connected to igniter cable 2. Igniter cable pinched or wet 3. Broken igniter cable 4. Bad igniter 5. Igniter electrode positioned wrong 6. Igniter electrode broken 7. Battery not installed, battery power low or battery not installed correctly (electronic ignition models only) 	<ol style="list-style-type: none"> 1. Reconnect igniter cable 2. Free igniter cable if pinched by any metal or tubing. Keep igniter cable dry 3. Replace igniter cable 4. Replace igniter 5. Replace pilot assembly 6. Replace pilot assembly 7. Install new alkaline battery in electronic igniter. Verify battery is installed correctly
When igniter button is pressed, there is spark at ODS/pilot but no ignition	<ol style="list-style-type: none"> 1. Gas supply turned off or equipment shutoff valve closed 2. Control knob not in PILOT position 3. Control knob not pressed in while in PILOT position 4. Air in gas lines when installed 5. Depleted gas supply (propane/LP only) 6. ODS/pilot is clogged 7. Gas regulator setting is not correct 	<ol style="list-style-type: none"> 1. Turn on gas supply or open equipment shutoff valve 2. Turn control knob to PILOT position 3. Press in control knob while in PILOT position 4. Continue holding down control knob. Repeat igniting operation until air is removed 5. Contact local propane/LP gas company 6. Clean ODS/pilot (<i>see <u>Cleaning and Maintenance, Page 27</u></i>) or replace ODS/pilot assembly 7. Replace gas regulator

TROUBLESHOOTING

Continued

OBSERVED PROBLEM	POSSIBLE CAUSE	REMEDY
<p>ODS/pilot lights but flame goes out when control knob is released</p>	<ol style="list-style-type: none"> 1. Control knob not fully pressed in 2. Control knob not pressed in long enough 3. Safety interlock system has been triggered 4. Equipment shutoff valve not fully open 5. Pilot flame not touching thermocouple, which allows thermocouple to cool, causing pilot flame to go out. This problem could be caused by one or both of the following: A) Low gas pressure B) Dirty or partially clogged ODS/pilot 6. Thermocouple connection loose at control valve 7. Thermocouple damaged 8. Control valve damaged 	<ol style="list-style-type: none"> 1. Press in control knob fully 2. After ODS/pilot lights, keep control knob pressed in 30 seconds 3. Wait one minute for safety interlock system to reset. Repeat ignition operation 4. Fully open equipment shutoff valve 5. A) Contact local natural or propane/LP gas company B) Clean ODS/pilot (see <u><i>Cleaning and Maintenance, Page 27</i></u>) or replace ODS/pilot assembly 6. Hand tighten until snug, then tighten 1/4 turn more 7. Replace pilot assembly 8. Replace control valve
<p>One or both burners do not light after ODS/pilot is lit</p>	<ol style="list-style-type: none"> 1. Inlet gas pressure is too low 2. Burner orifice(s) clogged 3. Mislocated crossover tube 4. Wire disconnected from gas control 	<ol style="list-style-type: none"> 1. Contact local natural or propane/LP gas company 2. Clean burner(s) (see <u><i>Cleaning and Maintenance, Page 27</i></u>) or replace burner orifice(s) 3. Contact qualified service person 4. See <u><i>Wiring Diagram, Page 28</i></u>
<p>Delayed ignition of one or both burners</p>	<ol style="list-style-type: none"> 1. Manifold pressure is too low 2. Burner orifice(s) clogged 3. Mislocated crossover tube 	<ol style="list-style-type: none"> 1. Contact local natural or propane/LP gas company 2. Clean burner(s) (see <u><i>Cleaning and Maintenance, Page 27</i></u>) or replace burner orifice(s) 3. Contact qualified service person
<p>Burner backfiring during combustion</p>	<ol style="list-style-type: none"> 1. Burner orifice is clogged or damaged 2. Damaged burner 3. Gas regulator defective 	<ol style="list-style-type: none"> 1. Clean burner (see <u><i>Cleaning and Maintenance, Page 27</i></u>) or replace burner orifice 2. Replace damaged burner 3. Replace gas regulator

TROUBLESHOOTING

Continued

OBSERVED PROBLEM	POSSIBLE CAUSE	REMEDY
Yellow flame in front burner during burner combustion	<ol style="list-style-type: none"> 1. Not enough air 2. Gas regulator defective 	<ol style="list-style-type: none"> 1. Check burner(s) for dirt and debris. If found, clean burner(s) (see <i>Cleaning and Maintenance, Page 27</i>) 2. Replace gas regulator
Slight smoke or odor during initial operation	<ol style="list-style-type: none"> 1. Residues from manufacturing processes and logs curing 	<ol style="list-style-type: none"> 1. Problem will stop after a few hours of operation
Heater produces a whistling noise when burners are lit	<ol style="list-style-type: none"> 1. Turning control knob to HI position when burners are cold 2. Air in gas line 3. Air passageways on heater blocked 4. Dirty or partially clogged burner orifice(s) 	<ol style="list-style-type: none"> 1. Turn control knob to LO position and let warm up for a minute 2. Operate burners until air is removed from line. Have gas line checked by local natural or propane/LP gas company 3. Observe minimum installation clearances (see <i>Pages 9 through 11</i>) 4. Clean burners (see <i>Cleaning and Maintenance, Page 27</i>) or replace burner orifice(s)
White powder residue forming within burner box or on adjacent walls or furniture	<ol style="list-style-type: none"> 1. When heated, vapors from furniture polish, wax, carpet cleaners, etc. may turn into white powder residue 	<ol style="list-style-type: none"> 1. Turn heater off when using furniture polish, wax, carpet cleaners or similar products
Moisture/condensation noticed on windows	<ol style="list-style-type: none"> 1. Not enough combustion/ventilation air 	<ol style="list-style-type: none"> 1. Refer to <i>Air for Combustion and Ventilation</i> requirements (<i>Page 6</i>)
Heater produces a clicking/ticking noise just after burners are lit or shut off	<ol style="list-style-type: none"> 1. Metal expanding while heating or contracting while cooling 	<ol style="list-style-type: none"> 1. This is normal with most heaters. If noise is excessive, contact qualified service person

TROUBLESHOOTING

Continued



WARNING: If you smell gas

- Shut off gas supply.
- Do not try to light any appliance.
- Do not touch any electrical switch; do not use any phone in your building.
- Immediately call your gas supplier from a neighbor's phone. Follow the gas supplier's instructions.
- If you cannot reach your gas supplier, call the fire department.

IMPORTANT: Operating heater where impurities in air exist may create odors. Cleaning supplies, paint, paint remover, cigarette smoke, cements and glues, new carpet or textiles, etc., create fumes. These fumes may mix with combustion air and create odors. These odors will disappear over time.

OBSERVED PROBLEM	POSSIBLE CAUSE	REMEDY
Heater produces unwanted odors	<ol style="list-style-type: none"> 1. Heater burning vapors from paint, hair spray, glues, cleaners, chemicals, new carpet, etc. (See IMPORTANT statement above) 2. Low fuel supply (propane/LP only) 3. Gas leak. See Warning statement at top of page 	<ol style="list-style-type: none"> 1. Open window to ventilate room. Stop using odor causing products while heater is running 2. Refill supply tank (propane/LP only) 3. Locate and correct all leaks (see <u>Checking Gas Connections, Page 16</u>)
Heater shuts off in use (ODS operates)	<ol style="list-style-type: none"> 1. Not enough fresh air is available 2. Low line pressure 3. ODS/pilot is partially clogged 	<ol style="list-style-type: none"> 1. Open window and/or door for ventilation 2. Contact local natural or propane/LP gas company 3. Clean ODS/pilot (see <u>Cleaning and Maintenance, Page 27</u>)
Gas odor even when control knob is in OFF position	<ol style="list-style-type: none"> 1. Gas leak. See Warning statement at top of page 2. Control valve or gas control defective 	<ol style="list-style-type: none"> 1. Locate and correct all leaks (see <u>Checking Gas Connections, Page 16</u>) 2. Replace control valve or gas control
Gas odor during combustion	<ol style="list-style-type: none"> 1. Foreign matter between control valve and burner 2. Gas leak. See Warning statement at top of page 	<ol style="list-style-type: none"> 1. Take apart gas tubing and remove foreign matter 2. Locate and correct all leaks (see <u>Checking Gas Connections, Page 16</u>)
Log set cycles to pilot, but room temperature drops to a lower than ideal level before log set comes back on	<ol style="list-style-type: none"> 1. Optional Hand-held remote control is too close to heater (Remote-Ready Models Only) 	<ol style="list-style-type: none"> 1. Move hand-held remote control unit farther away from the heater

WIRING DIAGRAM

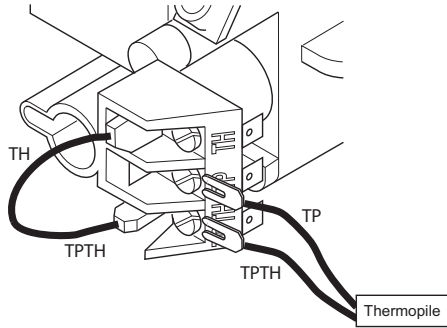

Figure 49 - Wiring Diagram - SIT Millivolt

⚠ CAUTION: Label all wires prior to disconnection when servicing controls. Wiring errors can cause improper and dangerous operation. Verify proper operation after servicing.

REPLACEMENT PARTS

See **Pages 37-41** for a complete replacement parts list. Use only parts supplied from the manufacturer.

Normally, all parts should be ordered through your IHP distributor or dealer. Parts will be shipped at prevailing prices at time of order.

When ordering repair parts, always give the following information:

1. The model number of the appliance.
2. The serial number of the appliance.
3. The part number.
4. The description of the part.
5. The quantity required.
6. The installation date of the appliance.

If you encounter any problems or have any questions concerning the installation or application of this appliance, please contact your dealer.

SERVICE HINTS

When Gas Pressure Is Too Low

- pilot will not stay lit
- burners will have delayed ignition
- appliance will not produce specified heat
- propane/LP gas supply may be low

You may feel your gas pressure is too low. If so, contact your local propane/LP or natural gas supplier.

TECHNICAL SERVICE

You may have further questions about installation, operation, or troubleshooting. Please contact your IHP dealer for any questions or concerns. When contacting your dealer please have your model and serial numbers of your appliance ready. You can also visit our web site at SuperiorFireplaces.us.com.

ACCESSORIES

Purchase these appliance accessories from your local dealer. If they can not supply these accessories, contact IHP at SuperiorFireplaces.us.com for referral information. You can also write to the address listed on the back page of this manual.

Only kits supplied by IHP shall be used in the installation of this appliance. Use of non-approved accessory/part kit(s) can result in poor performance and safety hazards.

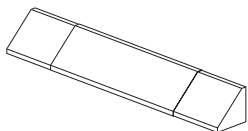

FIREPLACE HOOD, BLACK

Cat. No. F1764, Model GA6050

For all models. Helps deflect heat away from mantel or wall above fireplace. Fits openings 28" to 48" wide.



RECEIVER AND HAND-HELD THERMOSTAT REMOTE CONTROL KIT

Cat. No. F1078, Model TRC

For all models. Allows the fireplace to be operated in a manually or thermostatically controlled mode. You can turn the fireplace on and off without ever leaving the comfort of your easy chair.

VOLCANIC STONE

Cat. No. 80L42, Model FDVS

For all models. Order when additional volcanic stone is desired.

EMBER KITS

Platinum Embers

Cat. No J6207



Glowing Embers (rockwool)

Cat. No J6208

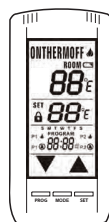

RECEIVER AND REMOTE CONTROL KIT Cat. No. F1079, Model TSRC

For all Remote-Ready Models. Allows the burner system to be operated in a manually or thermostatically controlled mode. Remote is programmable for your convenience and has a large bright LCD Touch Screen for easy use.



ON/OFF REMOTE AND RECEIVER WITH WHITE WALL PLATE

Cat. No. F2236, Model RCKIT 4001

For all Remote-Ready Models. Allows the fireplace to be turned on and off by using a hand-held remote control.



WALL-MOUNT THERMOSTAT SWITCH

Cat. No. F2040, Model GWMT1

For all models. The desired comfort setting can be selected on the wall thermostat and the log heater will automatically cycle from pilot to the heat setting selected.

ACCESSORIES

Continued

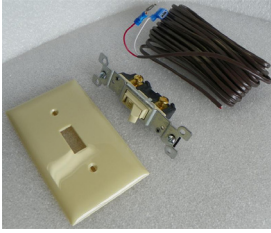

WALL-MOUNT ON/OFF SWITCH

Cat. No. F0245, Model GWMS2

For all models. Allows the gas log heater to be turned on and off with a wall switch.



LOG SCRAPS / FLOOR MEDIA KIT-1

Cat. No. F0250, Model VTA-LS5-1



FLOOR MEDIA KIT

Cat. No. F1762, Model FM100

For all models. Includes volcanic stone, burner embers, and burner cinders



LOG SCRAPS / FLOOR MEDIA KIT-2

Cat. No. F0251, Model VTA-LS5-2



GAS APPLIANCE INSTALLATION KIT

Cat. No. F0249, Model CIKA



DECORATIVE ASH BED / CONTROL COVER KIT (SIX PACK)

Cat. No. F1759, Model CDABKA-6

DECORATIVE ASH BED / CONTROL COVER KIT

Cat. No. F0246, Model CDABKA

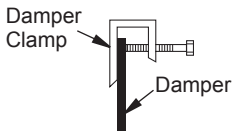

DAMPER CLAMP

Cat. No. F1760, Model GA6080

For all models. Permanently opens chimney flue damper for vented operation.

SPECIFICATIONS

BGE18PR

- Rating (Variable): 21,000/28,000 Btu/Hr
- Type Gas: Propane/LP
- Ignition: Electronic
- Manifold Pressure: 7.9" W.C.
- Inlet Gas Pressure (in. of water):
Max - 14" W.C., Min* - 11" W.C.

BGE2436PR

- Rating (Variable): 27,000/39,000 Btu/Hr
- Type Gas: Propane/LP
- Ignition: Electronic
- Manifold Pressure: 7.9" W.C.
- Inlet Gas Pressure (in. of water):
Max - 14" W.C., Min* - 11" W.C.

BGE18NR

- Rating (Variable): 19,000/28,000 Btu/Hr
- Type Gas: Natural
- Ignition: Electronic
- Manifold Pressure: 3.4" W.C.
- Inlet Gas Pressure (in. of water):
Max - 10.5" W.C., Min* - 5" W.C.

BGE2436NR

- Rating (Variable): 25,000/39,000 Btu/Hr
- Type Gas: Natural
- Ignition: Electronic
- Manifold Pressure: 3.4" W.C.
- Inlet Gas Pressure (in. of water):
Max - 10.5" W.C., Min* - 5" W.C.

*For purpose of input adjustment

GLOW RAMP™ BURNERS		
Cat. No.	Model	Description
F0040	BGE18NR	18" Millivolt, Ramp Burner, Embers, Natural Gas
F0044	BGE18PR	18" Millivolt, Ramp Burner, Emberss, Propane Gas
F0048	BGE2436NR	24" Millivolt, Ramp Burner, Emberss, Natural Gas
F0051	BGE2436PR	24" Millivolt, Ramp Burner, Embers, Propane Gas
LOG SETS		
F0053	LBG18BM	18" Boulder Mountain™, Concrete Log Set
F0054	LBG24BM	24" Boulder Mountain, Concrete Log Set
F0055	LBG30BM	30" Boulder Mountain, Concrete Log Set
F0056	LBG18SM	18" Smokey Mountain™, Ceramic Fiber Log Set
F0057	LBG24SM	24" Smokey Mountain, Ceramic Fiber Log Set
F0058	LBG30SM	30" Smokey Mountain, Ceramic Fiber Log Set
F1714	LBG36SM	36" Smokey Mountain, Ceramic Fiber Log Set

NOTES:

- *18" log sets can only be used with 18" burners.*
- *24", 30" and 36" log sets can only be used with 24" burners.*

PARTS

REMOTE-READY CONTROL MODELS BGE18NR, BGE18PR, BGE2436NR, BGE2436PR

⚠ WARNING: Failure to position the parts in accordance with these diagrams or failure to use only parts specifically approved with this heater may result in property damage or personal injury.

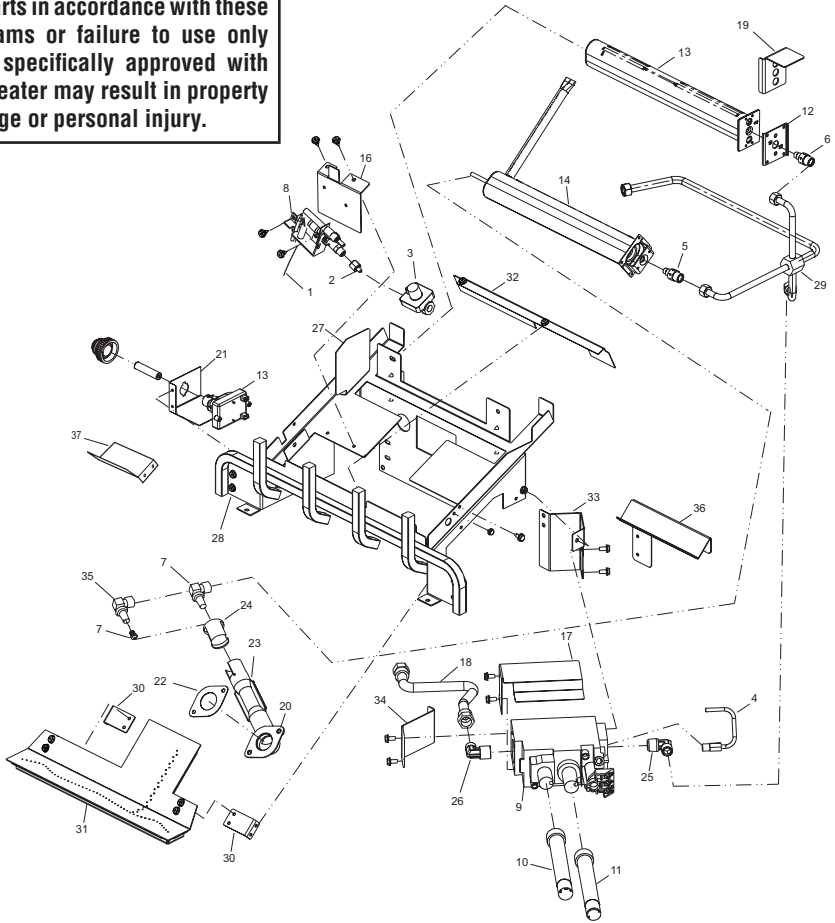

PARTS AVAILABLE NOT SHOWN

KEY NO.	PART NO.	DESCRIPTION	BGE18NR	BGE18PR	BGE2436NR	BGE2436PR	QTY.
	J3720	Wire Harness	•	•	•	•	1
	J3658	Warning Plate	•	•	•	•	1
	J3846	Lighting Instruction Plate	•	•	•	•	1
	J3664	Caution Decal	•	•	•	•	1
	J3689	Hardware Kit	•	•	•	•	1
	80L42	Volcanic Stone, FDVS	•	•	•	•	1
	J6504	Left Ember Chunk #1	•	•	•	•	1
	J6505	Middle Ember Chunk #2	•	•	•	•	1
	J6506	Right Ember Chunk #3	•	•	•	•	1
	J6208	Glowing Embers (rockwool)	•	•	•	•	1
	J6207	Platinum Embers	•	•	•	•	1
	J3656	Switch	•	•	•	•	1
	J3793	Wire Harness	•	•	•	•	1

** Not a field replaceable part.

PARTS

This list contains replaceable parts used in your appliance. When ordering parts, follow the instructions listed under Replacement Parts on **Page 33** of this manual.

KEY NO.	PART NO.	DESCRIPTION	BGE18NR	BGE18PR	BGE2436NR	BGE2436PR	QTY.
1	J3571	Cable Igniter	•	•	•	•	1
2	J3635	Pilot Tube LP		•		•	1
	J3637	Pilot Tube NG	•		•		1
3	J3654	Pilot Regulator	•		•		1
4	J3660	Pilot Tubing	•		•		1
5	J3671	Orifice, 0.0750	•		•		1
	J3674	Orifice, 0.0400		•			1
	J3679	Orifice, 0.0470				•	1
6	J3674	Orifice, 0.0400		•			1
	J3677	Orifice, 0.0595	•				1
	J3678	Orifice, 0.0720			•		1
	J3679	Orifice, 0.0470				•	1
7	J4725	Orifice Elbow	•		•		1
	J4726	Orifice Elbow				•	1
	J8079	Orifice, 0.0280		•			1
8	J3830	Pilot, ODS LP		•			1
	J3831	Pilot, ODS NG	•		•		1
9	J3836	Gas Valve NG	•		•		1
	J3837	Gas Valve LP		•		•	1
10	J3842	Knob Extension Pilot	•	•	•	•	1
11	J3843	Knob Extension HI-LO	•	•	•	•	1
12	**	Plate, NG Conversion	•		•		1
13	J4596	Electronic Igniter	•	•	•	•	1
14	J4818	Front Ramp Burner	•	•			1
	J4819	Front Ramp Burner			•	•	1
15	J4923	Rear Ramp Burner	•	•			1
	J4924	Rear Ramp Burner			•	•	1
16	J4842	Pilot Bracket	•	•	•	•	1
17	J4846	Heat Shield	•	•	•	•	1
18	J8174	Flex Tube	•	•	•	•	1
19	J5674	Air Shield				•	1
20	J3547	Captive Washer Nut	•	•	•	•	2
21	J6144	Igniter Bracket	•	•	•	•	1
22	J5456	Burner Gasket	•	•	•	•	1
23	J5416	Venturi	•	•	•	•	1
24	J4886	Air Shutter	•	•	•	•	1
25	J5418	Elbow	•	•	•	•	1
26	J3564	Elbow	•	•	•	•	1
27							
28	**	Assembly, Ramp Base	•	•	•	•	1
29	RP125468-01	Burner Inlet Tube	•	•			1
	J6488	Burner Inlet Tube			•	•	1
30	J6397	Pan Burner Bracket	•	•	•	•	2
31	J6398	Pan Burner Assembly	•	•			1
	J6399	Pan Burner Assembly			•	•	1
32	RP125489-01	Air Shield	•	•			1
	RP125489-02	Air Shield			•	•	1
33	F3177	Valve Support Bracket	•	•	•	•	1
34	F3178	Valve Support Bracket	•	•	•	•	1
35	J6127	Orifice Holder		•			1
36	J6490	Log Support Bracket			•	•	1
37	J5535	Log Support Bracket			•	•	1

PARTS

LOG MODELS

LBG18SM, LBG24SM, LBG30SM (SMOKEY MOUNTAIN)

This list contains replaceable parts used in your appliance. When ordering parts, follow the instructions listed under *Replacement Parts* on **Page 33** of this manual.

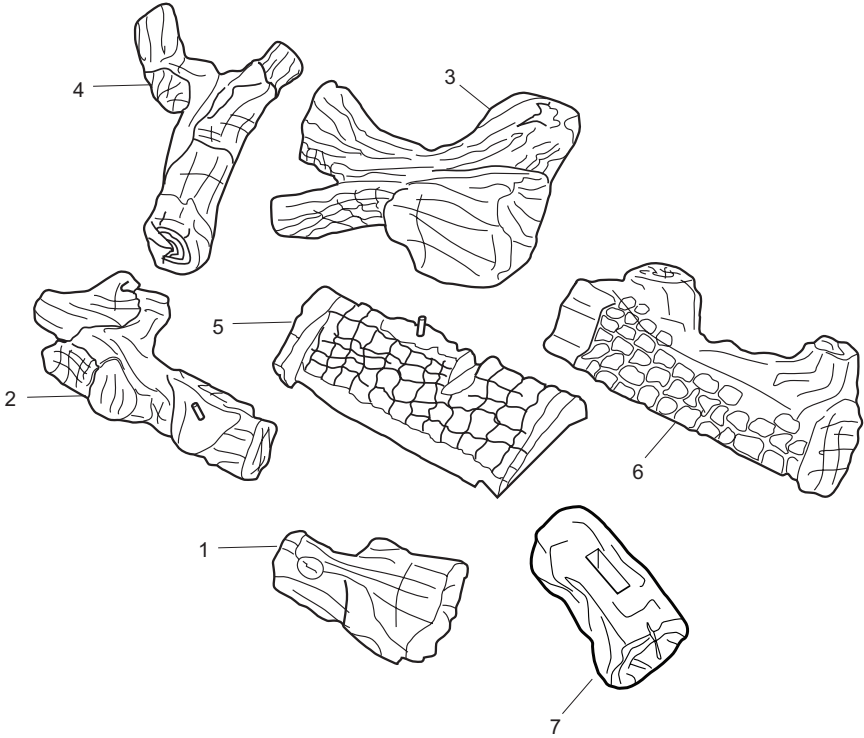

KEY NO.	MODEL NUMBER			DESCRIPTION	QTY
	LBG18SM	LBG24SM	LBG30SM		
1	J5708	J5714	J5720	Front Right Log	1
2	J5707	J5713	J5719	Front Left Log	1
3	J5705	J6554	J6554	Middle Right Log	1
4	J5706	J5712	J5718	Middle Left Log	1
5	J5704	J5716	J5716	Bottom Log (Remote)	1
6	J5709	J5715	J5721	Rear Log	1
7	J6747	J6747	J6747	Switch Log	1

PARTS

LOG MODELS

LBG36SM (SMOKEY MOUNTAIN)

This list contains replaceable parts used in your appliance. When ordering parts, follow the instructions listed under Replacement Parts on **Page 33** of this manual.

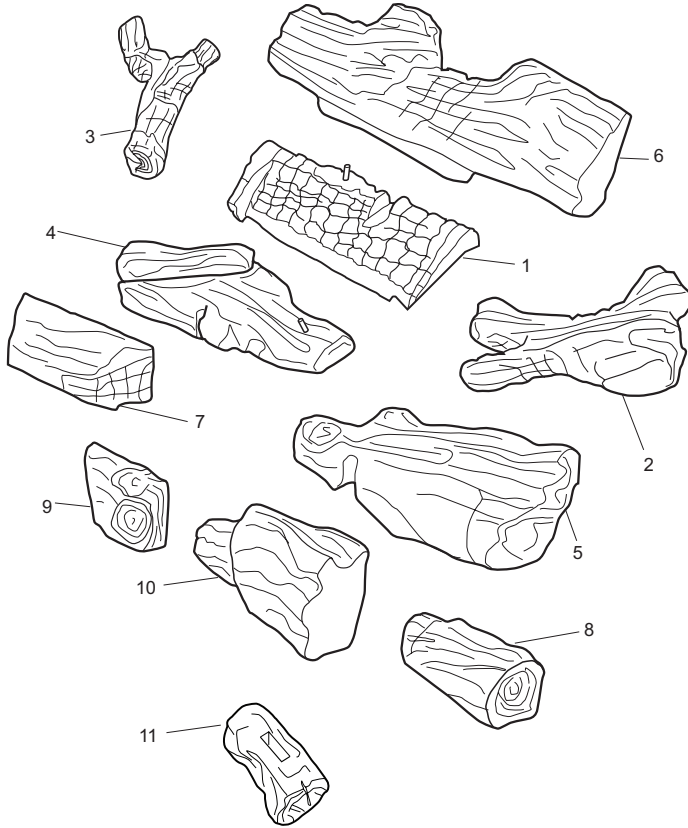

KEY NO.	MODEL NUMBER	DESCRIPTION	QTY
1	J5716	Bottom Log	1
2	J6554	Middle Right Log	1
3	J5718	Middle Left Log	1
4	J5722	Front Left Log	1
5	J5723	Front Right Log	1
6	J5724	Back Log	1
7	J5725	Left Small Front Log	1
8	J5726	Right Small Front Log	1
9	J5727	Left Control Cover Log	1
10	J5728	Right Control Cover Log	1
11	J6747	Switch Log	1

PARTS

LOG MODELS LBG18BM, LBG24BM, LBG30BM (BOULDER MOUNTAIN)

This list contains replaceable parts used in your appliance. When ordering parts, follow the instructions listed under Replacement Parts on **Page 33** of this manual.

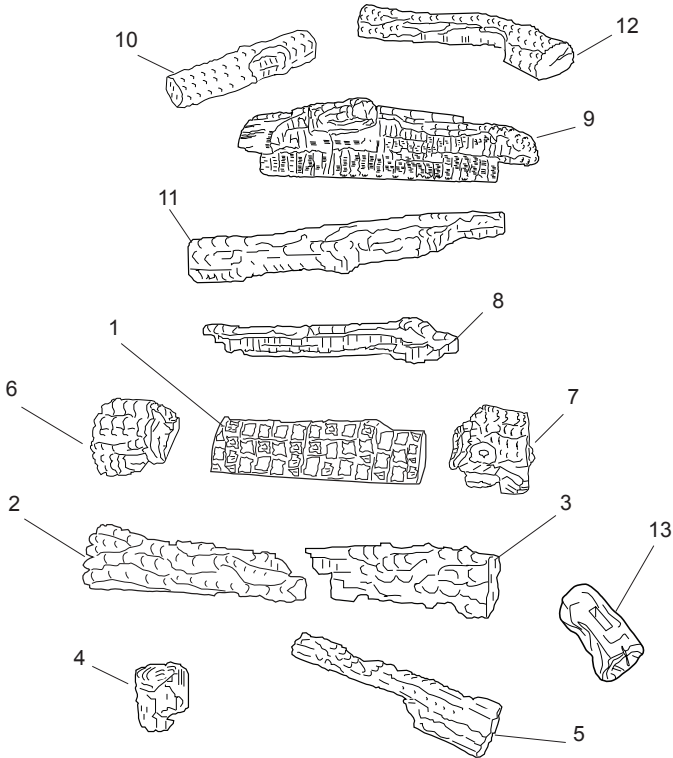

LOG MODELS LBG18BM, LBG24BM, LBG30BM

Cross reference log numbers.

KEY No.	LBG18BM	LOG ID No.	LBG24BM	LOG ID No.	LBG30BM	LOG ID No.	DESCRIPTION	QTY
1	J6631	NONE	J6641	NONE	J6641	NONE	Log, Ramp	1
2	J6632	D-064	J6642	D-057	J6652	D-038	Log, Left Front	1
3	J6633	D-065	J6643	D-058	J6653	D-039	Log, Right Front	1
4	J6634	D-073	J6644	D-048	J6644	D-048	Log, Left Front Ember Bed	1
5	J6635	D-072	J6645	D-047	J6645	D-047	Log, Right Front Ember Bed	1
6	F2943	D-066	J6646	D-040	J6646	D-040	Log, Left Middle	1
7	F2944	D-067	K2008	D-041	K2008	D-041	Log, Right Middle	1
8	J6636	D-068	J6647	D-042	J6647	D-042	Log, Rear Middle	1
9	J7518	D-069	J6648	D-043	J6648	D-043	Log, Rear	1
10	J6637	D-046	J6637	D-046	J6637	D-046	Log, Left Top	1
11	J6638	D-070	J6650	D-044	J6650	D-044	Log, Middle Crossover	1
12	J6639	D-071	J6651	D-045	J6651	D-045	Log, Top Rear	1
13	J5669	NONE	J5669	NONE	J5669	NONE	Log, LBGBM Switch	1

Innovative Hearth Products Superior® Brand Gas Log Set Limited Three Year Warranty

THE WARRANTY

Innovative Hearth Products Limited Three Year Warranty ("IHP") warrants your Superior® brand Gas Log Set ("Product") to be free from defects in materials and workmanship at the time of manufacture. The logs and grate carry the Limited Three Year Warranty. After installation, if covered components manufactured by IHP are found to be defective in materials or workmanship during the Limited Three Year Warranty period and while the Product remains at the site of the original installation, IHP will, at its option, repair or replace the covered components. If repair or replacement is not commercially practical, IHP will, at its option, refund the purchase price or wholesale price of the IHP product, whichever is applicable. IHP will also pay IHP prevailing labor rates, as determined in its sole discretion, incurred in repairing or replacing such components. THERE ARE EXCLUSIONS AND LIMITATIONS to this Limited Three Year Warranty as described herein.

COVERAGE COMMENCEMENT DATE

Warranty coverage begins on the date of purchase. In the case of new home construction, warranty coverage begins on the date of first occupancy of the dwelling or six months after the sale of the Product by an independent IHP dealer, whichever occurs earlier. The warranty shall commence no later than 24 months following the date of product shipment from IHP, regardless of the installation or occupancy date.

EXCLUSIONS AND LIMITATIONS

This Limited Three Year Warranty applies only if the Product is installed in the United States or Canada and only if operated and maintained in accordance with the printed instructions accompanying the Product and in compliance with all applicable installation and building codes and good trade practices.

This warranty is non-transferable and extends to the original owner only. The Product must be purchased through a listed supplier of IHP and proof of purchase must be provided. The following do not carry the Limited Three Year Warranty but are warranted as follows:

Gas components – Repair or replacement for one year from the date of installation.

Remote control – Repair or replacement for one year from the date of installation.

Labor coverage – Prevailing IHP labor rates apply for the warranty period of the component.

Parts not otherwise listed carry a 90 day warranty from the date of installation.

Whenever practicable, IHP will provide replacement parts, if available, for a period of 10 years from the last date of manufacture of the product.

IHP will not be responsible for: (a) damages caused by normal wear and tear, accident, riot, fire, flood or acts of God; (b) damages caused by abuse, negligence, misuse, or unauthorized alteration or repair of the Product affecting its stability or performance (The Product must be subjected to normal use. The Product is designed to burn either natural or propane gas only. Burning conventional fuels such as wood, coal or any other solid fuel will cause damage to the Product, will produce excessive temperatures and could result in a fire hazard.); (c) damages caused by failing to provide proper maintenance and service in accordance with the instructions provided with the Product; (d) damages, repairs or inefficiency resulting from faulty installation or application of the Product.

This Limited Three Year Warranty covers only parts and labor as provided herein. In no case shall IHP be responsible for materials, components or construction which are not manufactured or supplied by IHP or for the labor necessary to install, repair or remove such materials, components or construction. Additional utility bills incurred due to any malfunction or defect in equipment are not covered by this warranty. All replacement or repair components will be shipped F.O.B. from the nearest stocking IHP factory.

LIMITATION ON LIABILITY

It is expressly agreed and understood that IHP's sole obligation and the purchaser's exclusive remedy under this warranty, under any other warranty, expressed or implied, or in contract, tort or otherwise, shall be limited to replacement, repair, or refund, as specified herein.

In no event shall IHP be liable for any incidental or consequential damages caused by defects in the Product, whether such damage occurs or is discovered before or after replacement or repair, and whether such damage is caused by IHP's negligence. IHP has not made and does not make any representation or warranty of fitness for a particular use or purpose, and there is no implied condition of fitness for a particular use or purpose.

IHP makes no expressed warranties except as stated in this Limited Three Year Warranty. The duration of any implied warranty is limited to the duration of this expressed warranty.

No one is authorized to change this Limited Three Year Warranty or to create for IHP any other obligation or liability in connection with the Product. Some states and provinces do not allow the exclusion or limitation of incidental or consequential damages, so the above limitations or exclusions may not apply to you. The provisions of this Limited Three Year Warranty are in addition to and not a modification of or subtraction from any statutory warranties and other rights and remedies provided by law.

INVESTIGATION OF CLAIMS AGAINST WARRANTY

IHP reserves the right to investigate any and all claims against this Limited Three Year Warranty and to decide, in its sole discretion, upon the method of settlement.

To receive the benefits and advantages described in this Limited Three Year Warranty, the appliance must be installed and repaired by a licensed contractor approved by IHP.

Contact IHP at the address provided herein to obtain a listing of approved dealers/distributors. **IHP shall in no event be responsible for any warranty work done by a contractor that is not approved without first obtaining IHP's prior written consent.**

HOW TO REGISTER A CLAIM AGAINST WARRANTY

In order for any claim under this warranty to be valid, you must contact the IHP dealer/distributor from which you purchased the product. If you cannot locate the dealer/distributor, then you must notify IHP in writing. IHP must be notified of the claimed defect in writing within 90 days of the date of failure. Notices should be directed to the IHP Warranty Department at 1769 East Lawrence Street; Russellville, AL 35654 or visit our website at WWW.SUPERIORFIREPLACES.US.COM.

SuperiorFireplaces.us.com

Record the following important information about your appliance:

Appliance model number	
Appliance serial number	
Date appliance was Installed	
Type of gas appliance uses	
Dealer name	

IHP reserves the right to make changes at any time, without notice, in design, materials, specifications, prices and also to discontinue colors, styles and products. Consult your local distributor for fireplace code information.

